



Epson[®] SureColor[®] P600 User's Guide

Contents

SureColor P600 User's Guide	11
Product Basics	12
Using the Control Panel	12
Control Panel Buttons and Lights	12
The Touch Screen	13
Status Icons	14
Adjusting Control Panel Position	15
Changing Touch Screen Language	16
Adjusting the Screen Brightness	16
Product Parts Locations	17
Product Parts - Front	18
Product Parts - Inside	19
Product Parts - Back	20
The Power Off and Sleep Timers	20
Changing the Power Off Timer Setting from the Control Panel	21
Changing the Sleep Timer Setting from the Control Panel	22
Changing the Power Off Timer Setting - Windows	22
Changing the Power Off Timer Setting - OS X	23
Epson Connect Solutions for Smartphones, Tablets, and More	24
Using the Epson iPrint Mobile App	25
Using Epson Remote Print	25
Using AirPrint	26
Using Google Cloud Print	26
Setting Up Google Cloud Print on a Chromebook	27
Wi-Fi or Wired Networking	29
Wi-Fi Infrastructure Mode Setup	29
Selecting Wireless Network Settings from the Control Panel	30
Wi-Fi Direct Mode Setup	32
Enabling Wi-Fi Direct Mode	33
Wi-Fi Protected Setup (WPS)	36

Using WPS to Connect to a Network	36
Printing a Network Status Sheet.....	37
Changing or Updating Network Connections	38
Accessing the Web Config Utility	38
Changing a USB Connection to a Wi-Fi Connection.....	38
Changing a Wi-Fi Connection to a Wired Network Connection.....	39
Connecting to a New Wi-Fi Router	39
Disabling Wi-Fi Features	40
Loading Media	41
Loading Paper in the Sheet Feeder.....	41
Loading Fine Art Media	44
Loading Posterboard and Thick Media.....	48
Loading Roll Paper.....	52
Cutting and Removing Roll Paper	55
Cut Sheet Media Loading Capacity	57
Available Epson Papers	59
Borderless Paper Type Compatibility	65
Paper or Media Type Settings - Product Software.....	66
Selecting the Paper Settings for Each Source - Control Panel	68
Paper or Media Type Settings - Control Panel.....	68
Selecting the Default Paper Setup Display and Error Notice Settings	70
Printing from a Computer	72
Printing with Windows	72
Selecting Basic Print Settings - Windows	72
Paper Configuration Options - Windows	75
Advanced B&W Photo Options - Windows.....	76
Print Quality Options - Windows	77
Color Management Options - Windows	77
Advanced Color Controls - Windows	79
Paper Source Options - Windows	79
Using Layout Manager - Windows Only	81
Selecting Print Layout Options - Windows.....	87
Reduce/Enlarge Options - Windows	88

Multi-Page Printing Options - Windows.....	88
Double-sided Printing Options - Windows.....	89
Selecting Additional Settings - Windows	89
Printing Your Document or Photo - Windows.....	91
Checking Print Status - Windows	93
Saving, Sharing, and Customizing the Printer Settings	93
Saving and Sharing Print Settings - Windows	94
Saving and Sharing Media Settings - Windows.....	95
Editing Print Setting Displays - Windows	96
Selecting Default Print Settings - Windows.....	98
Changing the Language of the Printer Software Screens	100
Changing Automatic Update Options	101
Printing with OS X	102
Selecting Basic Print Settings - OS X	102
Advanced Color Settings - OS X.....	108
Output Resolution Settings - OS X.....	110
Print Options - OS X.....	110
Selecting Roll Paper Settings - OS X.....	111
Selecting Paper Configuration Settings - OS X.....	113
Advanced Media Control Options - OS X.....	113
Selecting Print Layout Options - OS X.....	114
Managing Color - OS X.....	114
Color Matching Options - OS X.....	115
Sizing Printed Images - OS X	116
Selecting Printing Preferences - OS X.....	116
Printing Preferences - OS X.....	117
Printing Your Document or Photo - OS X.....	118
Checking Print Status - OS X.....	118
Printing on CDs/DVDs.....	120
Loading a CD/DVD.....	120
Removing a Printed CD/DVD	122
Printing on CDs/DVDs from a Computer	123
Starting Epson Print CD - Windows.....	123

Printing Your CD/DVD Design - Windows	124
Starting Epson Print CD - OS X	125
Printing Your CD/DVD Design - OS X.....	126
Replacing Ink Cartridges	127
Check Cartridge Status	127
Checking Cartridge Status on the LCD Screen.....	127
Checking Cartridge Status with Windows.....	128
Checking Cartridge Status with OS X.....	130
Purchase Epson Ink Cartridges.....	131
Ink Cartridge Part Numbers	131
Removing and Installing Ink Cartridges.....	132
Switch Black Ink Type	136
Black Ink Type Media List.....	136
Switching the Black Ink Type.....	137
Adjusting Print Quality.....	138
Print Head Maintenance.....	138
Print Head Nozzle Check.....	138
Checking the Nozzles Using the Product Control Panel	138
Checking the Nozzles Using a Computer Utility	140
Print Head Cleaning	142
Cleaning the Print Head Using the Product Control Panel	142
Cleaning the Print Head Using a Computer Utility.....	144
Print Head Alignment	146
Aligning the Print Head Using the Product Control Panel	147
Aligning the Print Head Using a Computer Utility.....	148
Cleaning the Paper Guide	150
Cleaning and Transporting Your Product	151
Cleaning Your Product	151
Transporting Your Product	151
Solving Problems	158
Checking for Software Updates.....	158
Product Status Messages	159

Running a Product Check	160
Resetting Control Panel Defaults	161
Solving Setup Problems	162
Noise After Ink Installation	163
Software Installation Problems	163
Solving Network Problems	164
Product Cannot Connect to a Wireless Router or Access Point	164
Network Software Cannot Find Product on a Network.....	165
Product Does Not Appear in OS X Printer Window.....	166
Cannot Print Over a Network.....	167
Solving Paper Problems.....	168
Paper Feeding Problems.....	168
Paper Jam Problems in the Sheet Feeder.....	170
Paper Jam Problems in the Front Manual Feed Tray	171
Paper Jam Problems - Thick Media.....	172
Paper Jam Problems - Roll Paper	174
Paper Ejection Problems	175
Solving Problems Printing from a Computer.....	176
Nothing Prints	176
Product Icon Does Not Appear in Windows Taskbar	177
Error After Cartridge Replacement	177
Printing is Slow	178
Solving Page Layout and Content Problems.....	179
Inverted Image.....	179
Too Many Copies Print	180
Blank Pages Print	180
Incorrect Margins on Printout.....	181
Border Appears on Borderless Prints	181
Incorrect Characters Print.....	181
Incorrect Image Size or Position	182
Slanted Printout	182
Solving Print Quality Problems.....	183
White or Dark Lines in Printout	183

Blurry or Smearred Printout	184
Faint Printout or Printout Has Gaps	185
Grainy Printout.....	186
Incorrect Colors	187
Solving CD/DVD Problems.....	188
CD/DVD Jam Problems.....	188
Image Not Centered on CD/DVD.....	189
Image Does Not Cover Printable Area of Disc.....	189
Ink Smears on CD/DVD.....	189
Faint Image on CD/DVD	189
Uninstall Your Product Software.....	189
Uninstalling Printing Software - Windows	190
Uninstalling Product Software - OS X	190
Where to Get Help.....	191
Technical Specifications	193
Windows System Requirements	193
OS X System Requirements.....	193
Paper Specifications	194
Printable Area Specifications	195
Ink Cartridge Specifications.....	200
Dimension Specifications	201
Electrical Specifications	201
Environmental Specifications	202
Interface Specifications	203
Network Interface Specifications	203
Safety and Approvals Specifications	203
Notices	205
Important Safety Instructions.....	205
General Printer Safety Instructions.....	205
Ink Cartridge Safety Instructions.....	207
LCD Screen Safety Instructions.....	207
Wireless Connection Safety Instructions	208
FCC Compliance Statement.....	208

Trademarks	209
Copyright Notice.....	209
A Note Concerning Responsible Use of Copyrighted Materials.....	210
Default Delay Times for Power Management for Epson Products	210
Copyright Attribution	210

SureColor P600 User's Guide

Welcome to the SureColor P600 *User's Guide*.

For a printable PDF copy of this guide, [click here](#).

Product Basics

See these sections to learn about the basic features of your product.

[Using the Control Panel](#)

[Product Parts Locations](#)

[The Power Off and Sleep Timers](#)

[Epson Connect Solutions for Smartphones, Tablets, and More](#)

[Using AirPrint](#)

[Using Google Cloud Print](#)

Using the Control Panel

See these sections to learn about the control panel and select control panel settings.

[Control Panel Buttons and Lights](#)

[The Touch Screen](#)

[Adjusting Control Panel Position](#)





[Changing Touch Screen Language](#)

[Adjusting the Screen Brightness](#)

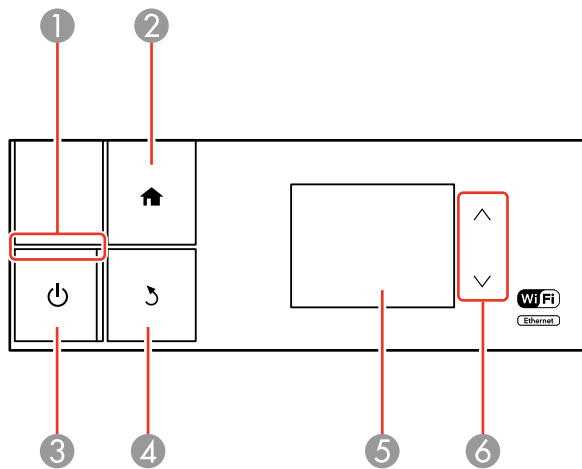
Parent topic: [Product Basics](#)

Control Panel Buttons and Lights



- 1 The  power light
- 2 The  home button
- 3 The  power button
- 4 The  back button
- 5 The touch screen
- 6 The up and down arrow buttons

Parent topic: [Using the Control Panel](#)

The Touch Screen











- 1 Status icons
- 2 **Load Guide** displays when no paper is loaded; **Media Setup** displays when paper is loaded
- 3 Opens the ink cartridge menu
- 4 Changes the black ink type
- 5 Opens the networking menu
- 6 Opens the setup menu
- 7 Ejects paper







Status Icons

Parent topic: [Using the Control Panel](#)

Status Icons

Status icons may be displayed on the touch screen depending on the product's status.

Icons	Description
	Photo Black ink is selected.
	Matte Black ink is selected.
	Ink is low.
	Displays the status of the Ethernet connection.
	Wired or wireless network connection has been established.
	Wi-Fi connection has been established. The number of lit bars indicates the connection's signal strength.
	Ad hoc connection has been established.
	Wi-Fi Direct mode connection has been established.
	Simple AP mode connection has been established.

Icons	Description
	Auto Sheet Feeder setting is selected (displays in Load Guide).
	Fine Art Media setting is selected (displays in Load Guide).
	Poster Board setting is selected (displays in Load Guide).
	CD/DVD setting is selected (displays in Load Guide).
	Roll Paper setting is selected (displays in Load Guide).
	Thick Paper setting is set to On .

Parent topic: [The Touch Screen](#)

Adjusting Control Panel Position

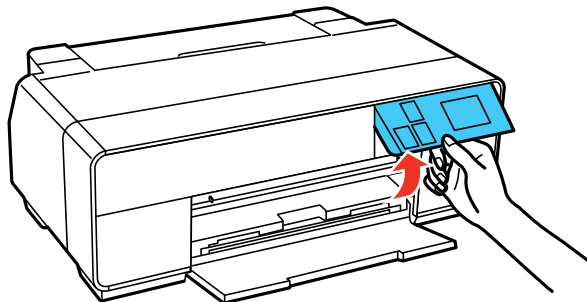

You can adjust the position of the control panel to make it easier to access. Raise or lower it to the desired angle as shown.



Parent topic: [Using the Control Panel](#)

Changing Touch Screen Language

You can change the language used on the touch screen.

1. Press the  home button, if necessary.
2. Press the  setup button.

You see a screen like this:

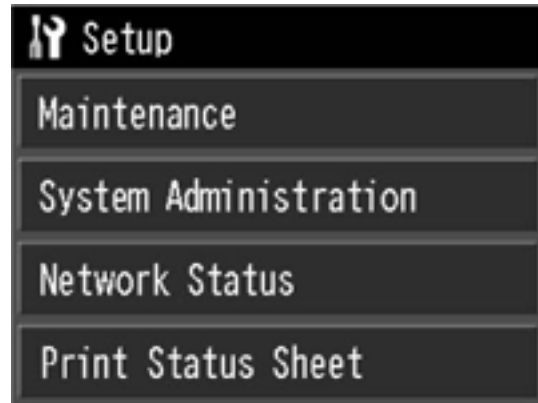



3. Select **System Administration**. Enter the administrator password, if necessary.
4. Select **Common Settings**.
5. Press the down arrow button and select **Language**.
6. Select a language.

Parent topic: [Using the Control Panel](#)

Adjusting the Screen Brightness

You can adjust the brightness of the LCD screen.

1. Press the  home button, if necessary.
2. Press the  setup button.

You see a screen like this:

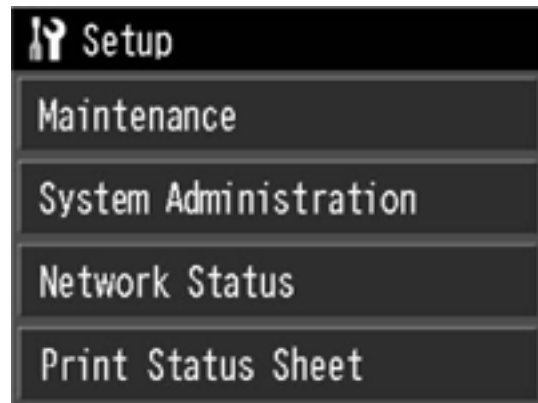

3. Select **System Administration**. Enter the administrator password, if necessary.
4. Select **Common Settings**.
5. Select **LCD Brightness**.
6. Tap the left or right arrows to adjust the screen brightness.
7. Select **OK** to exit.

Parent topic: [Using the Control Panel](#)

Product Parts Locations

See these sections to identify the parts on your product.

[Product Parts - Front](#)

[Product Parts - Inside](#)

[Product Parts - Back](#)

Parent topic: [Product Basics](#)

Product Parts - Front

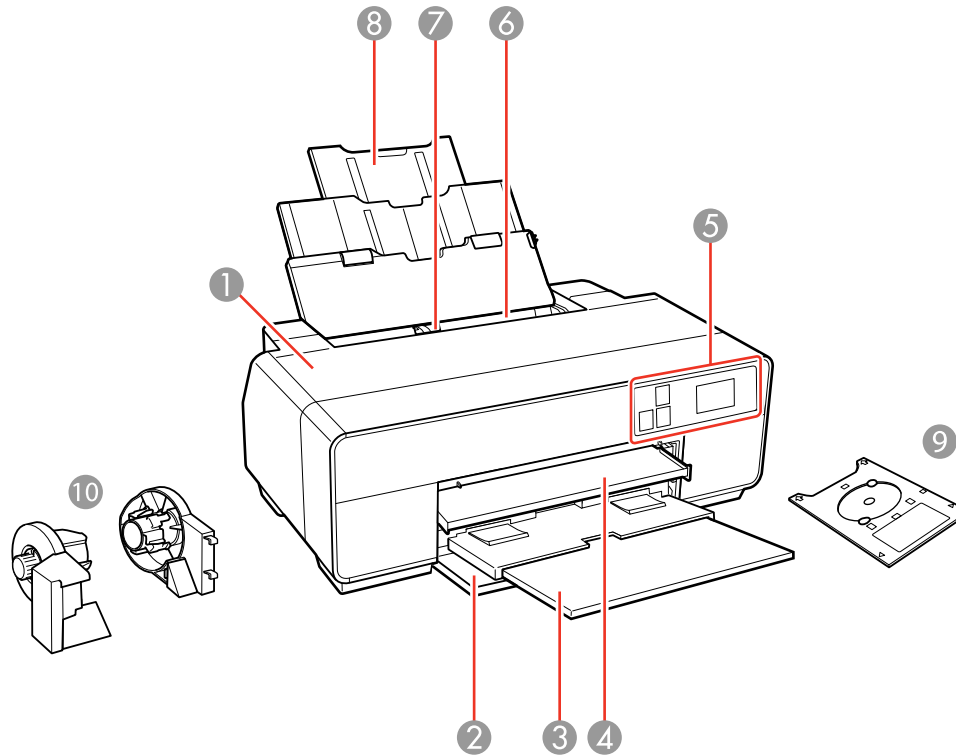

- 1 Printer cover
- 2 Front cover
- 3 Output tray
- 4 Front manual feed tray
- 5 Control panel
- 6 Sheet feeder
- 7 Edge guide
- 8 Paper support and extensions

- 9 CD tray
- 10 Roll paper holders

Parent topic: [Product Parts Locations](#)

Product Parts - Inside

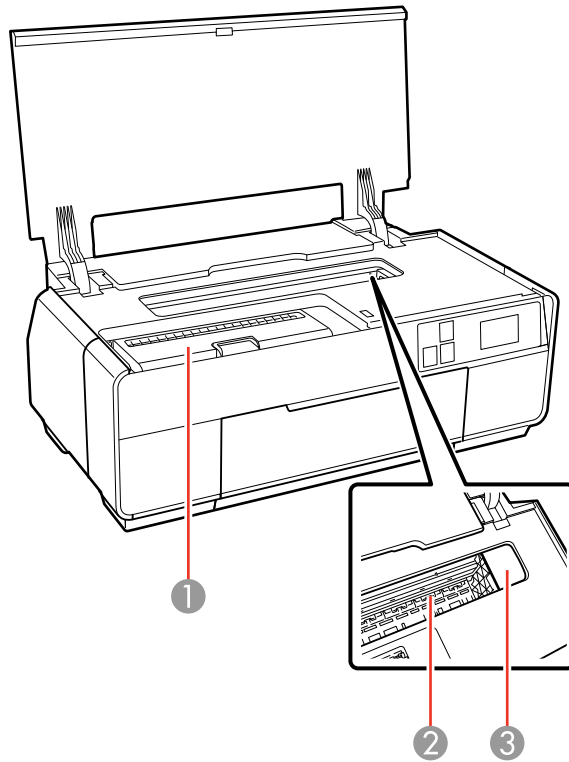

- 1 Ink cartridge cover
- 2 Ink pad
- 3 Print head

Parent topic: [Product Parts Locations](#)

Product Parts - Back

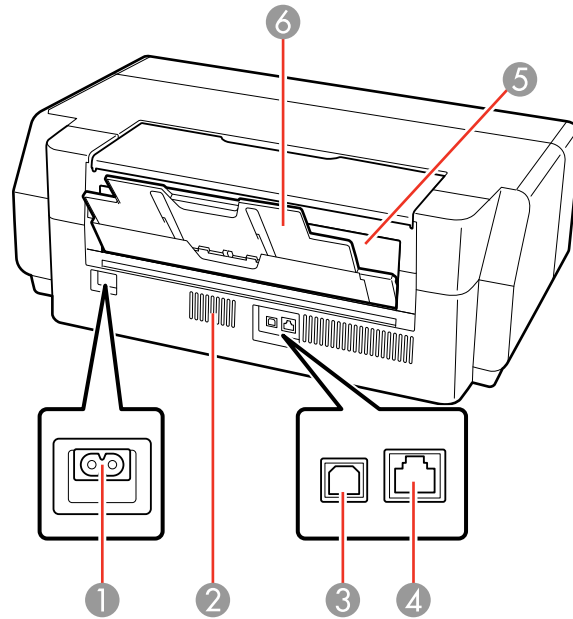

- 1 AC inlet
- 2 Vent
- 3 **USB** port
- 4 **LAN** port
- 5 Roll paper feed slot
- 6 Rear paper support and extension

Parent topic: [Product Parts Locations](#)

The Power Off and Sleep Timers

The product enters sleep mode or turns off automatically if it is not used for a period of time. You can adjust the time period before power management, but increasing the time reduces the product's energy efficiency.

[Changing the Power Off Timer Setting from the Control Panel](#)

[Changing the Sleep Timer Setting from the Control Panel](#)



[Changing the Power Off Timer Setting - Windows](#)

[Changing the Power Off Timer Setting - OS X](#)

Parent topic: [Product Basics](#)

Changing the Power Off Timer Setting from the Control Panel

You can use the product's control panel to change the time period before the printer turns off automatically.

1. Press the  home button, if necessary.
2. Press the  setup button.

You see a screen like this:

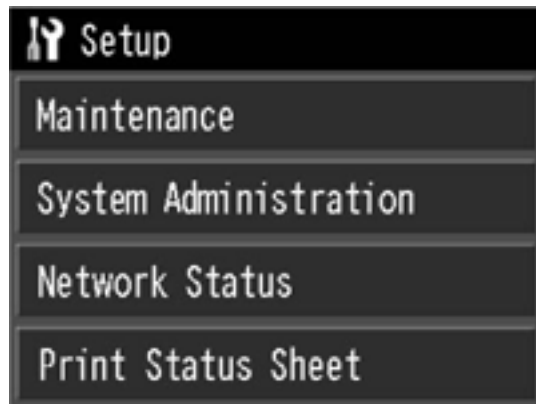



3. Select **System Administration**.
4. Select **Common Settings**.
5. Select **Power Off Timer**.
6. Select the length of time after which you want the product to automatically turn off when it is not in use.

Parent topic: [The Power Off and Sleep Timers](#)

Changing the Sleep Timer Setting from the Control Panel

You can use the product's control panel to change the time period before the product enters sleep mode.

1. Press the  home button, if necessary.
2. Press the  setup button.

You see a screen like this:

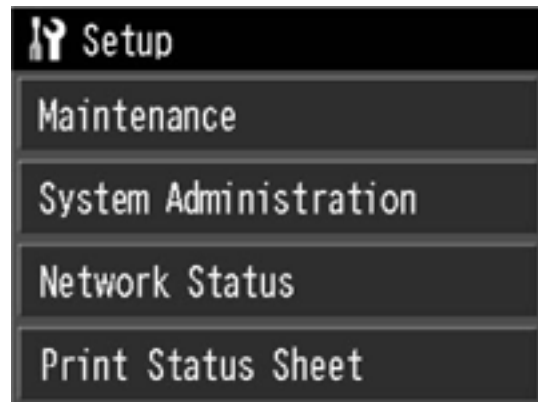

3. Select **System Administration**.
4. Select **Common Settings**.
5. Select **Sleep Timer**.
6. Select **+** or **-** to select the time period you want before the product goes to sleep. Then select **OK**.

Parent topic: [The Power Off and Sleep Timers](#)

Changing the Power Off Timer Setting - Windows

You can use the printer software to change the time period before the printer turns off automatically.

1. Access the Windows Desktop, right-click the product icon in the Windows taskbar, and select **Printer Settings**.
2. Click the **Utility** tab and select **Printer and Option Information**.

You see this window:

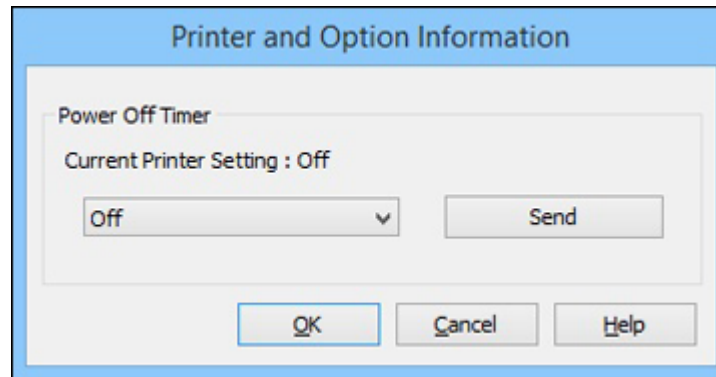

3. In the drop-down menu, select the length of time after which you want the product to automatically turn off when it is not in use.
4. Click **Send**.
5. When you see the time you selected listed as the Current Printer Setting, click **OK**.

Parent topic: [The Power Off and Sleep Timers](#)

Changing the Power Off Timer Setting - OS X

You can use the printer software to change the time period before the printer turns off automatically.

1. In the Apple menu or the Dock, select **System Preferences**. Select **Print & Fax**, **Print & Scan**, or **Printers & Scanners**, select your product, and select **Options & Supplies**. Select **Utility** and select **Open Printer Utility**.
2. Select **Printer Settings**.

You see this window:

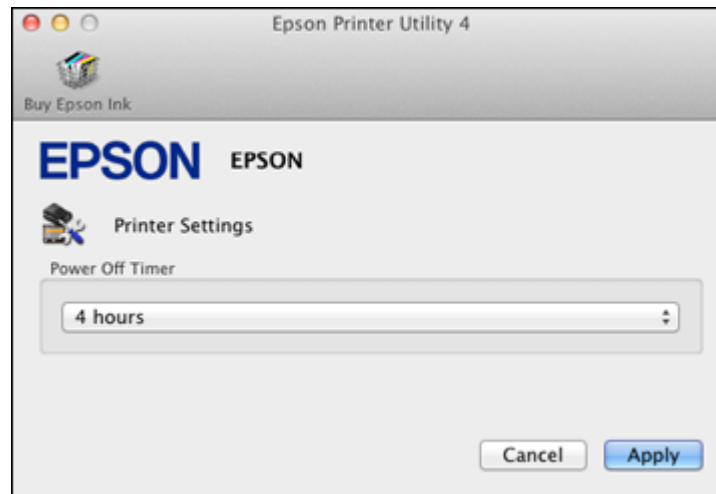

3. Select the length of time after which you want the product to automatically turn off when it is not in use as the **Power Off Timer** setting.
4. Click **Apply**.
5. Close the Printer Settings window.

Parent topic: [The Power Off and Sleep Timers](#)

Epson Connect Solutions for Smartphones, Tablets, and More

You can print documents, photos, and web pages from your home or office. You can use your smartphone, tablet, or computer. Epson offers these solutions to print from anywhere: Epson iPrint Mobile App and Epson Remote Print.

[Using the Epson iPrint Mobile App](#)

[Using Epson Remote Print](#)

Parent topic: [Product Basics](#)

Using the Epson iPrint Mobile App

Use this free Apple and Android app to print to nearby Epson networked products. The Epson iPrint Mobile App lets you print PDFs, Microsoft Office documents, photos, and web pages over a wireless network.

1. Set up your product on a network. See the link below.
2. Visit [epson.com/connect](https://www.epson.com/connect) to learn more about Epson iPrint and check the compatibility of your mobile device.
3. Download Epson iPrint from the Apple App Store or Google Play.
4. Connect your mobile device to the same wireless network that your product is using.
5. Print from your mobile device to your Epson product.

Parent topic: [Epson Connect Solutions for Smartphones, Tablets, and More](#)

Related topics

[Wi-Fi or Wired Networking](#)

Using Epson Remote Print

With Epson Remote Print software on your Windows computer or laptop, you can print to an Epson Email-enabled product anywhere in the world.

1. Set up your product for network printing. See the link below.
2. Visit [epson.com/connect](https://www.epson.com/connect) to learn more about Remote Print and how to download the software.
3. Download and install the Remote Print software.
4. Obtain the email address and optional access key of the Epson product you want to use for printing, and enter this address during Remote Print setup.
5. Select the print command in your application and choose the Remote Print driver for your Epson product.

Parent topic: [Epson Connect Solutions for Smartphones, Tablets, and More](#)

Related topics

[Wi-Fi or Wired Networking](#)

Using AirPrint

AirPrint enables instant wireless printing from iPhone, iPad, and iPod touch with the latest version of iOS, and Mac with the latest version of OS X.



Note: If you disabled paper configuration messages on your product control panel, you cannot use AirPrint. See the link below to enable the messages, if necessary.

1. Load paper in your product.
2. Set up your product for wireless printing. See the link below.
3. Connect your Apple device to the same wireless network that your product is using.
4. Print from your device to your product.

Note: For details, see the AirPrint page on the Apple website.

Parent topic: [Product Basics](#)

Related topics

[Wi-Fi or Wired Networking](#)

[Loading Media](#)

Using Google Cloud Print

With a Google Account, you can print from your Apple or Android device to your Epson product. You can also print from Chromebooks and the Google Chrome browser without drivers or cables.

Set up your Epson product for network printing. See the link below.

Note: Make sure your Epson printer and computer are connected to the same network before starting the Google Cloud Print setup.

1. Connect your device to the same network that your Epson product is using.
2. Print a network status sheet.

3. Locate your product's IP address on the network status sheet.
4. Enter the IP address into the address bar of a web browser.
5. Select the **Google Cloud Print Services** option.

Note: If you don't see the **Google Cloud Print Services** option, turn your product off and back on. If the option still doesn't appear, select the **Firmware Update** option and follow the on-screen instructions to update your product.

6. Click **Register**.
7. Select the checkbox to agree to the Usage Advisory and click **Next**.
8. Click **OK** to launch the sign-in page.
A separate browser window opens.
9. Enter your Google Account username and password and click **Sign in**, or, if you don't have an account, click **Sign up for a new Google Account** and follow the on-screen instructions.
10. Click **Finish printer registration** to complete setup and print a test page.

Your product is now linked to your Google Account and can be accessed from any Chromebook, computer, Apple or Android device with Internet access. Visit [Epson Support](#) for more information on using Google Cloud Print, or the [Google Cloud Print](#) website for a list of [supported apps](#).

[Setting Up Google Cloud Print on a Chromebook](#)

Parent topic: [Product Basics](#)

Related topics

[Wi-Fi or Wired Networking](#)

Setting Up Google Cloud Print on a Chromebook

With a Google Account, you can print from a Chromebook without drivers or cables.

Set up your Epson product for network printing. See the link below.

Note: Make sure your Epson product is connected to your wireless network before starting the Google Cloud Print setup.

1. Turn on your Chromebook and connect it to the same wireless network as your product.

Note: See your Chromebook's documentation for details on connecting to a network.

2. Do one of the following:
 - Click **Add to Cloud Print** in the notification that appears in the corner of your Chromebook screen.

Note: If you do not see a notification, check to see if a number appears in the status area at the lower-right corner of the screen. Click this number to open the notifications menu, then click **Add to Cloud Print**.
 - Open a web browser and enter **chrome://devices** in the address bar. Skip to step 4.
3. Click **Add Device**.
4. Click the **Register** button that appears next to your product.
5. Click **Register** on the confirmation screen. Your product's LCD screen displays a confirmation message.
6. Select **OK** or press the **OK** button on your product to confirm the Google Cloud Print connection and print a test page.

Your product is now linked to your Google Account and can be accessed from any Chromebook, iPhone, or Android phone with Internet access. For more information on using Google Cloud Print, visit [Epson Support](#).

Parent topic: [Using Google Cloud Print](#)

Wi-Fi or Wired Networking

See these sections to use your product on a Wi-Fi or wired network.

[Wi-Fi Infrastructure Mode Setup](#)

[Wi-Fi Direct Mode Setup](#)

[Wi-Fi Protected Setup \(WPS\)](#)

[Printing a Network Status Sheet](#)

[Changing or Updating Network Connections](#)

Wi-Fi Infrastructure Mode Setup

You can set up your product to communicate with your computer using a wireless router or access point. The wireless router or access point can be connected to your computer over a wireless or wired network.

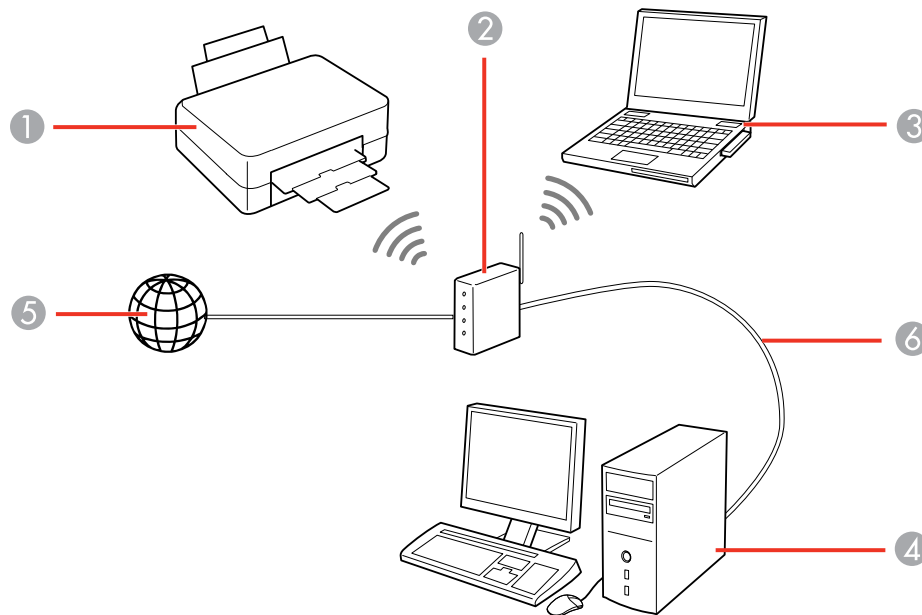

- 1 Epson product
- 2 Wireless router or access point

- 3 Computer with a wireless interface
- 4 Computer
- 5 Internet
- 6 Ethernet cable (used only for wired connection to the wireless router or access point)

[Selecting Wireless Network Settings from the Control Panel](#)



Parent topic: [Wi-Fi or Wired Networking](#)

Selecting Wireless Network Settings from the Control Panel

You can select or change wireless network settings using your product control panel.

To install your product on a wireless network, follow the instructions on the *Start Here* sheet and install the necessary software. The installer program guides you through network setup.

Note: Breakdown or repair of this product may cause loss of network data and settings. Epson is not responsible for backing up or recovering data and settings during or after the warranty period. We recommend that you make your own backup or print out your network data and settings.

1. Press the  home button, if necessary.
2. Press the  network status icon.
3. Select **Wi-Fi Setup**.

You see a screen like this:



4. Select **Wi-Fi Setup Wizard**.

Note: If you need to disable the wireless network to set up your product on an Ethernet network, press the down arrow button, select **Disable Wi-Fi**, and press the **OK** button. Then follow the instructions on changing to a wired network connection.







5. Select the name of your wireless network or enter the name manually.

Note: To enter the wireless network name manually, select **Other Networks** and select the **Network (SSID)** field. Use the displayed keypad to enter your network name.

6. Select the **Password** field and enter your wireless password using the displayed keypad.



Note: The network name and password are case sensitive. Be sure to correctly enter uppercase and lowercase letters, and numeric or special characters.

- Press  or  to move the cursor.
- Press  to change the case of letters.
- Press  to delete the previous character.
- Press  to enter numbers and symbols.
- Press  to enter a space.

7. Press  when you finish entering your password and select **Proceed**.
8. Confirm the displayed network settings and select **OK** to save them.

Note: If you need to change a setting, press the ↶ back button.

9. If you want to print a network setup report, select **Print**. (Otherwise, select **Done**.)
10. Press the  home button to exit.

Your product should now be connected to the network.

Note: If the WiFi connection symbol does not appear lit on the touch screen, you may have selected the wrong network name or entered the password incorrectly. Repeat these steps to try again.

Parent topic: [Wi-Fi Infrastructure Mode Setup](#)

Wi-Fi Direct Mode Setup

You can set up your product to communicate directly with your computer or another device without requiring a wireless router or access point.

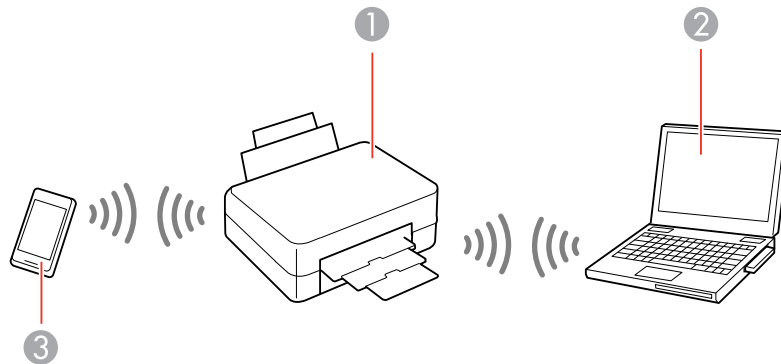

- 1 Epson product
- 2 Computer with a wireless interface
- 3 Other wireless device

You can select one of these modes to communicate with your computer or device:

Access point mode

The product itself acts as the network access point for up to 4 devices. When operating in this mode, your product displays an **AP** connection symbol on the LCD screen.

Peer-to-peer mode

The product communicates one-to-one with another Wi-Fi Direct capable device. When operating in this mode, your product displays a **Direct** or **D** connection symbol on the LCD screen.

To disconnect a peer-to-peer mode connection, release the connection to your product from your computer or other device.

To enable peer-to-peer mode, you must select it from the Web Config Utility, under **WiFi/Network Settings > Services > Wi-Fi Direct**.



[Enabling Wi-Fi Direct Mode](#)

Parent topic: [Wi-Fi or Wired Networking](#)

Enabling Wi-Fi Direct Mode

You can enable Wi-Fi Direct mode to allow direct communication between your product and a computer or other devices without a wireless router or access point.

Note: You may need to enable the Wi-Fi Direct setting in the **Advanced Setup** menu before you can enable Wi-Fi Direct mode.

1. Press the  home button, if necessary.
2. Press the  network status icon.
3. Select **Wi-Fi Setup**.

You see a screen like this:









4. Scroll down and select **Wi-Fi Direct Setup**.
5. Select **Connection Setup**.
6. Select **Change Password** and select **Yes**.

Note: If you have already connected devices or computers to your product via Wi-Fi Direct, they are disconnected when you change the password.

7. Enter your new Wi-Fi Direct password.



Note: Your password must be at least 8 and no more than 22 characters long.

- Press  or  to move the cursor.
 - Press  to change the case of letters.
 - Press  to delete the previous character.
 - Press  to enter numbers and symbols.
 - Press  to enter a space.
8. Press  when you finish entering your password.

You see a screen like this:



9. Scroll down to view the SSID (Wi-Fi network name) and password.
10. Use your computer or wireless device to select the Wi-Fi network name (SSID) displayed on the LCD screen, then enter the password shown.
11. Press the  home button to exit.

You see either an **AP** or **Direct** connection symbol on the LCD screen and should be able to print directly to your product from your computer or device.

Note: If the **AP** or **Direct** connection symbol is not displayed on the LCD screen, Wi-Fi Direct mode is not enabled. Repeat these steps to try again.

Parent topic: [Wi-Fi Direct Mode Setup](#)

Wi-Fi Protected Setup (WPS)

If your network uses a WPS-enabled wireless router or access point, you can quickly connect your product to the network using Wi-Fi Protected Setup (WPS).



Note: To check if your router is WPS-enabled, look for a button labeled **WPS** on your router or access point. If there is no hardware button, there may be a virtual WPS button in the software for the device. Check your network product documentation for details.

[Using WPS to Connect to a Network](#)

Parent topic: [Wi-Fi or Wired Networking](#)

Using WPS to Connect to a Network

If you have a WPS-enabled wireless router or access point, you can use Wi-Fi Protected Setup (WPS) to connect your product to the network.

1. Press the  home button, if necessary.
2. Press the  network status icon.
3. Select **Wi-Fi Setup**.

You see a screen like this:



4. Select **Push Button Setup (WPS)** and select **Proceed**.

5. Follow the instructions on the LCD screen to complete WPS setup.
6. Press the  home button to exit.

Your product should now be connected to the network.

Parent topic: [Wi-Fi Protected Setup \(WPS\)](#)

Printing a Network Status Sheet

You can print a network status sheet to help you determine the causes of any problems you may have using your product on a network.

1. Press the  home button, if necessary.
2. Press the  setup button.
3. Select **Network Status**.
4. Select **Wi-Fi/Network Status**.

You see a screen like this:



Note: If you are connected to a wireless network, the signal strength is also displayed.

5. Select **Print**.
6. Select **Print** again to print the network status sheet.

Examine the settings shown on the network status sheet to diagnose any problems you have.

Parent topic: [Wi-Fi or Wired Networking](#)

Changing or Updating Network Connections

See these sections to change or update how your product connects to a network.

[Accessing the Web Config Utility](#)

[Changing a USB Connection to a Wi-Fi Connection](#)

[Changing a Wi-Fi Connection to a Wired Network Connection](#)

[Connecting to a New Wi-Fi Router](#)

[Disabling Wi-Fi Features](#)

Parent topic: [Wi-Fi or Wired Networking](#)

Accessing the Web Config Utility

You can select your product's network settings and confirm its operating status using a web browser. You do this by accessing your product's built-in Web Config utility from a computer or other device that is connected to the same network as your product.

1. Print a network status sheet.
2. Locate the IP Address for your product that is listed on the network status sheet.
3. On a computer or other device connected to the same network as your product, open a web browser.
4. Enter your product's IP address into the address bar.

You see the available Web Config utility options.

Parent topic: [Changing or Updating Network Connections](#)

Related tasks

[Printing a Network Status Sheet](#)

Changing a USB Connection to a Wi-Fi Connection

If you have already connected your product to your computer using a USB connection, you can change to a Wi-Fi connection.

1. Disconnect the USB cable from your product.
2. Uninstall your product software.
3. Download and install your product software from the Epson website using the instructions on the *Start Here* sheet.

Parent topic: [Changing or Updating Network Connections](#)

Changing a Wi-Fi Connection to a Wired Network Connection

If you have already connected your product to your computer wirelessly, you can change to a wired network connection if necessary.

1. Disable your product's Wi-Fi features.
2. Connect one end of an Ethernet network cable to the product's **LAN** port.
3. Connect the other end to any available LAN port on your router or access point.
4. Uninstall your product software.
5. Download and install your product software from the Epson website.
6. Follow the on-screen instructions to install the software.
7. When you see the Select Your Connection screen, select **Wired network connection**.
8. If you see a Select Setup Option screen, select **Set up printer for the first time**.
9. Continue following the rest of the on-screen instructions.

Parent topic: [Changing or Updating Network Connections](#)

Related tasks

[Disabling Wi-Fi Features](#)

Connecting to a New Wi-Fi Router

If you change the wireless router you have been using on your network, you need to update your product's Wi-Fi connection to the new router.

Note: If you switch to a 5 GHz wireless router, set the router to operate in dual band (2.4 GHz and 5 GHz) mode. See your router documentation for instructions.

1. Do one of the following:
 - **Windows:** Uninstall your product software.
 - **OS X:** Go to the next step.
2. Download and install your product software from the Epson website using the instructions on the *Start Here* sheet.

Parent topic: [Changing or Updating Network Connections](#)



Related tasks

[Uninstalling Printing Software - Windows](#)

Disabling Wi-Fi Features

You may need to disable your product's Wi-Fi features if you change your network connection type or need to solve a problem with your network connection.

Note: Before disabling Wi-Fi features, make a note of your product's SSID (network name) and password, and any network settings selected for the Epson Connect services you may use.

1. Press the  home button, if necessary.
2. Press the  network status icon.
3. Select **Wi-Fi Setup**.

You see this screen:



4. Scroll down and select **Disable Wi-Fi**.
5. Select **Yes** to disable Wi-Fi.

Parent topic: [Changing or Updating Network Connections](#)

Loading Media

Before you print, load media for the type of printing you will do.

Note: Loading media automatically displays the setup screen for media type and size. To turn this display off, press the  setup button, select **System Administration > Printer Settings > Paper Source Settings > Paper Setup Display > Off**.

[Loading Paper in the Sheet Feeder](#)

[Loading Fine Art Media](#)

[Loading Posterboard and Thick Media](#)

[Loading Roll Paper](#)

[Cut Sheet Media Loading Capacity](#)

[Available Epson Papers](#)

[Borderless Paper Type Compatibility](#)

[Paper or Media Type Settings - Product Software](#)

[Selecting the Paper Settings for Each Source - Control Panel](#)

[Selecting the Default Paper Setup Display and Error Notice Settings](#)

Loading Paper in the Sheet Feeder

You can print on a variety of paper types and sizes from paper loaded in the sheet feeder.

1. Turn on your product.
2. Open the paper support and pull up the extensions.

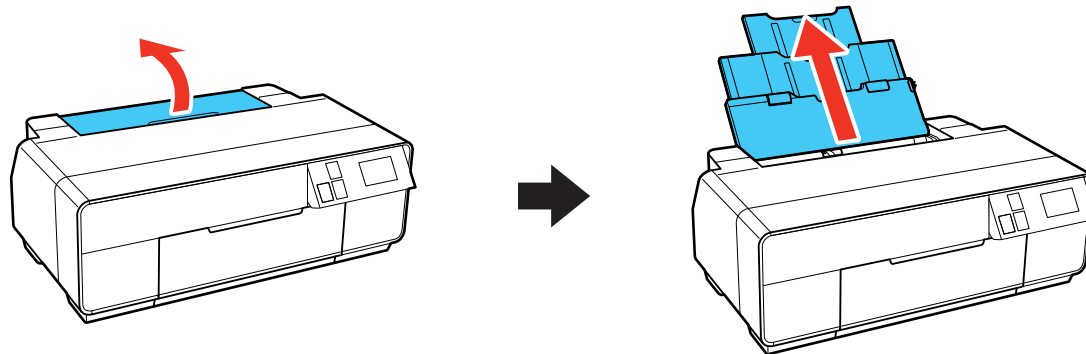

3. Open the front cover.

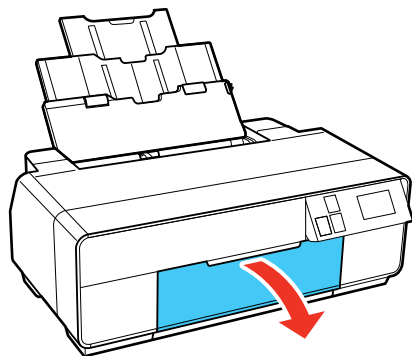

4. Extend the output tray.

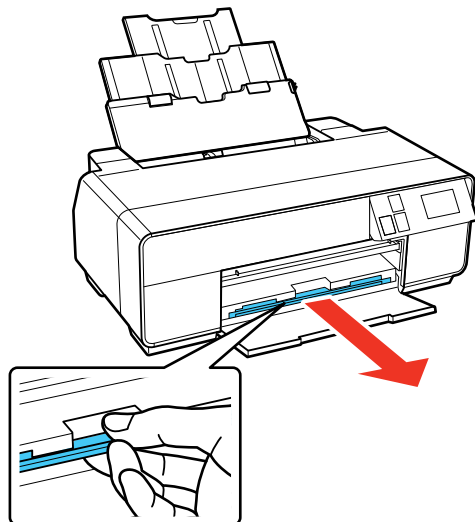

5. Insert paper, glossy or printable side up, short edge first, against the right edge and behind the tab.

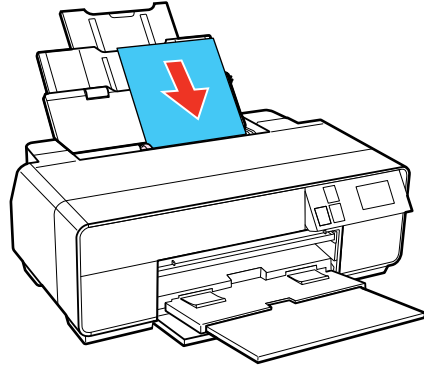

6. Press the button on the edge guide and slide it to the edge of the paper.

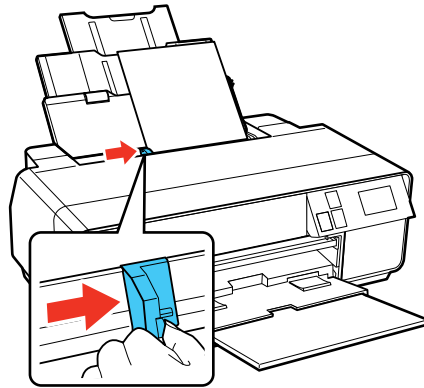

7. When prompted by the product's LCD screen, select the size and type of the paper you loaded and select **OK**.

Always follow these paper loading guidelines:

- Load only the recommended number of sheets.
- Load paper short edge first, no matter which way your document faces.
- Load the printable side faceup.

- Load letterhead or pre-printed paper top edge first.
- Do not load paper above the arrow mark inside the edge guide.
- Check the paper package for any additional loading instructions.

Parent topic: [Loading Media](#)

Related references

[Cut Sheet Media Loading Capacity](#)

Related tasks

[Loading Fine Art Media](#)

[Loading Posterboard and Thick Media](#)

[Selecting the Paper Settings for Each Source - Control Panel](#)

[Selecting the Default Paper Setup Display and Error Notice Settings](#)

Loading Fine Art Media

Use the front manual feed tray and the rear paper support to load fine art media.

Note: You can load fine art media with a thickness of 0.012 to 0.028 inch (0.3 to 0.7 mm).

1. Turn on your product.
2. Remove any paper from the sheet feeder and close the paper support.
3. Remove any roll paper and the roll paper holders.
4. Open the rear paper support.

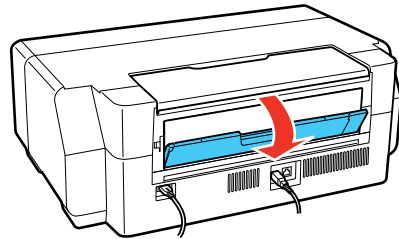

5. Pull out the rear paper support extensions.

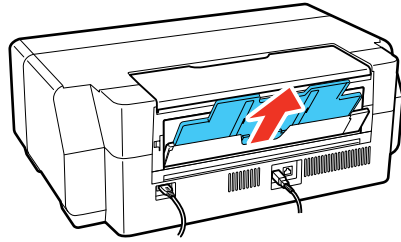

6. Open the front cover.

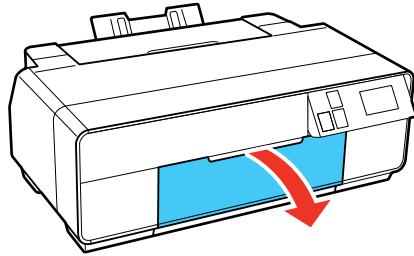

7. Press the center of the manual feed tray and release it to extend the tray.

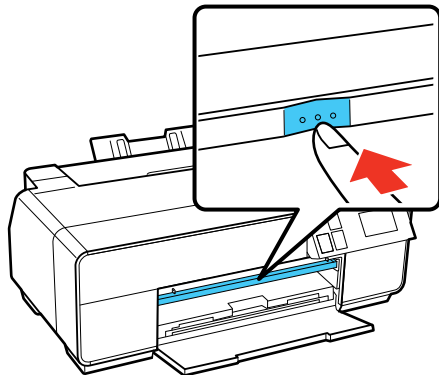

8. Insert a single sheet of fine art paper into the manual feed tray. Insert it short edge first with the printable side up.

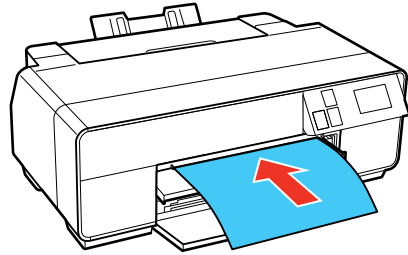

9. Feed the paper up to the line near the end of the tray. Make sure the paper is flush against the right side.

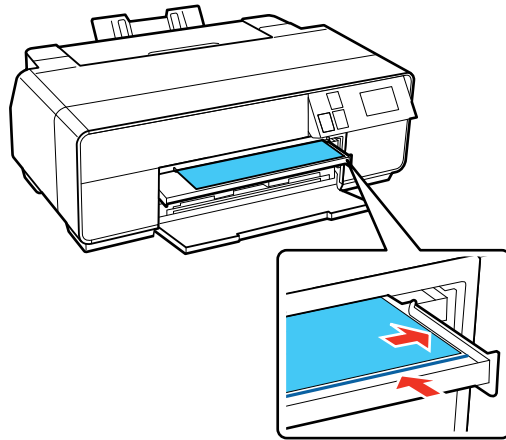

10. Select **Load** on the touch screen. The paper loads into your product.

11. When you see a message telling you to extend the output tray, pull out and extend the tray fully.

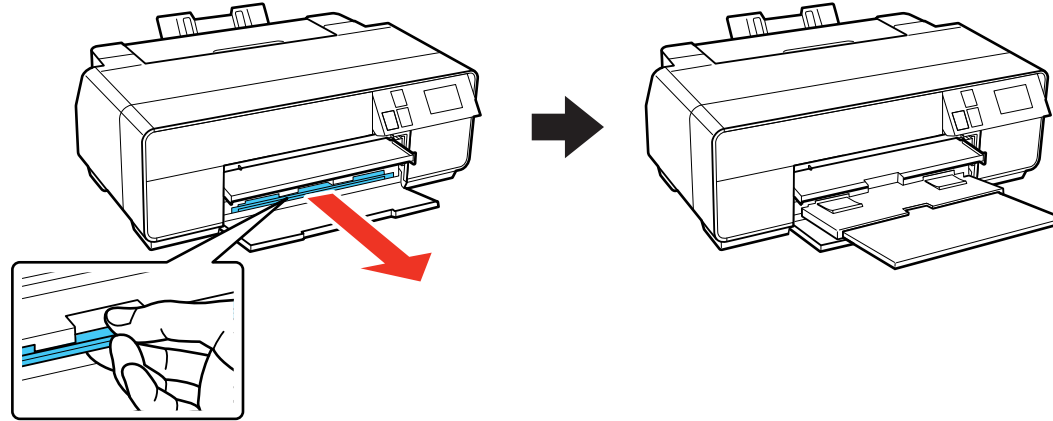

12. When prompted by the product's touch screen, select the size and type of the paper you loaded and select **OK**.

13. Push in the manual feed tray until it latches.

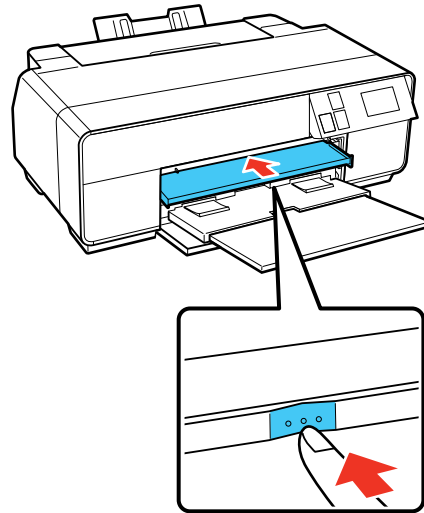

Note: To eject paper, select **Eject** on the touch screen and select **Yes** to confirm.

Always follow these paper loading guidelines:

- Load only one sheet at a time.
- Load fine art media short edge first, no matter which way your document faces.
- Load the printable side faceup.
- Check the paper package for any additional loading instructions.

Parent topic: [Loading Media](#)

Related references

[Cut Sheet Media Loading Capacity](#)

Related tasks

[Loading Paper in the Sheet Feeder](#)

[Loading Posterboard and Thick Media](#)

[Selecting the Paper Settings for Each Source - Control Panel](#)

[Selecting the Default Paper Setup Display and Error Notice Settings](#)

Loading Posterboard and Thick Media

Use the front manual feed tray to load media with a thickness of 0.028 to 0.051 inch (0.7 to 1.3 mm).

Note: Be sure to leave at least 13 inches (32 cm) of space behind your product for the media to feed through.

1. Turn on your product.
2. Remove any paper from the sheet feeder and close the paper support.
3. Remove any roll paper and the roll paper holders.

4. Close the rear paper support.

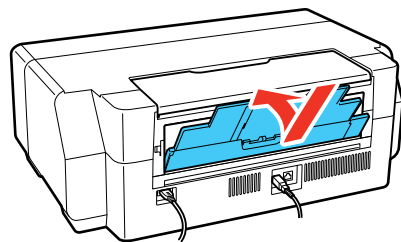

5. Open the front cover.

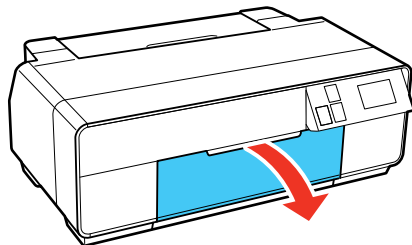

6. Press the center of the manual feed tray and release it to extend the tray.

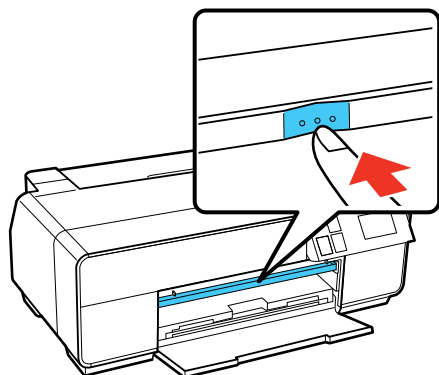

7. Insert a single sheet of posterboard or thick media into the manual feed tray. Insert it short edge first with the printable side up.

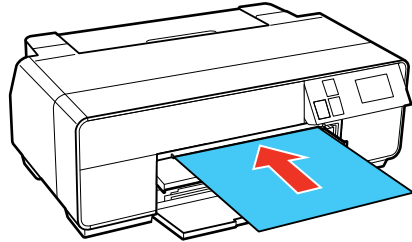

Note: Never try to load media from the rear, or you could damage your product.

8. Feed the paper up to the line near the end of the tray. Make sure the paper is flush against the right side.

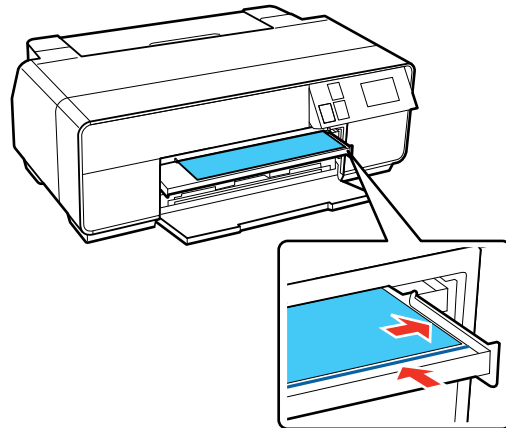

9. Select **Poster Board - Load** on the touch screen. The paper loads into your product.

10. When you see a message on the screen, push in the manual feed tray until it latches.

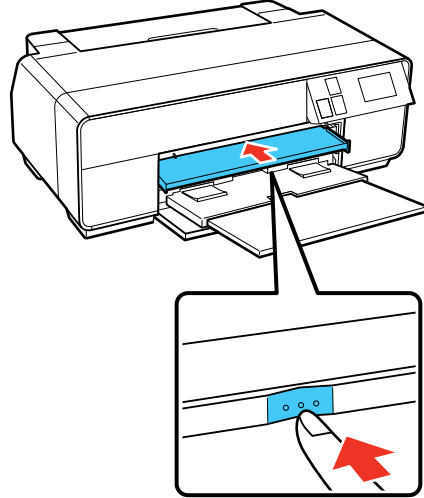

11. Fully extend the output tray.

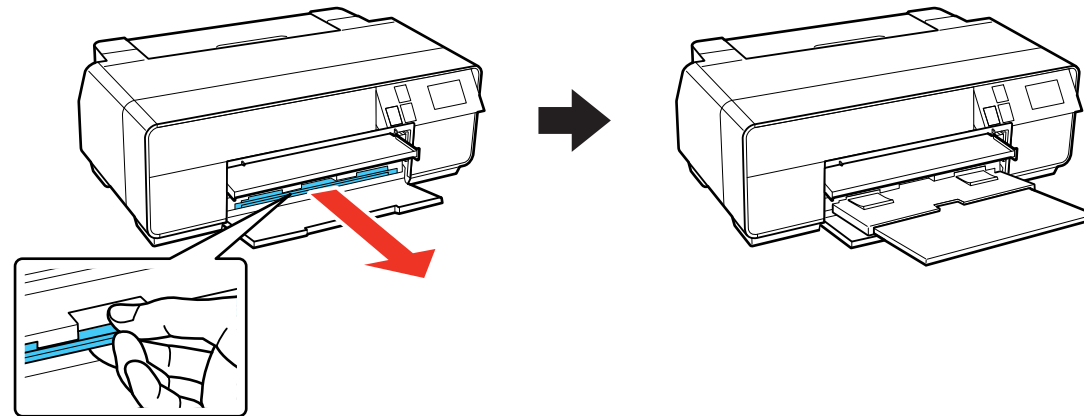

Note: To eject paper, select **Eject** on the touch screen and follow the displayed instructions. Do not extend the manual feed tray during printing, or you may damage your product.

Parent topic: [Loading Media](#)

Related references

[Cut Sheet Media Loading Capacity](#)

Related tasks

[Loading Paper in the Sheet Feeder](#)

[Loading Fine Art Media](#)

[Selecting the Paper Settings for Each Source - Control Panel](#)

[Selecting the Default Paper Setup Display and Error Notice Settings](#)

Loading Roll Paper

You can load 13-inch (330 mm) wide roll paper for printing large or panoramic images, or multiple photos (with or without borders).

Note: It's a good idea to check the ink status and replace cartridges, if necessary, before printing a large print job. If you need to replace a cartridge during printing, you can continue to print but you might notice a color difference in your printout depending on drying conditions.

1. Turn on your product.
2. Remove any paper from the sheet feeder and close the paper support.
3. Open the front cover.

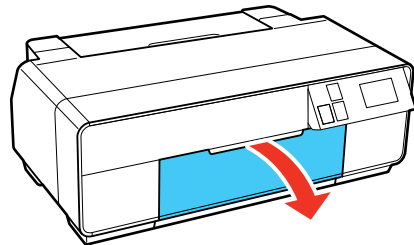

4. Fully extend the output tray.

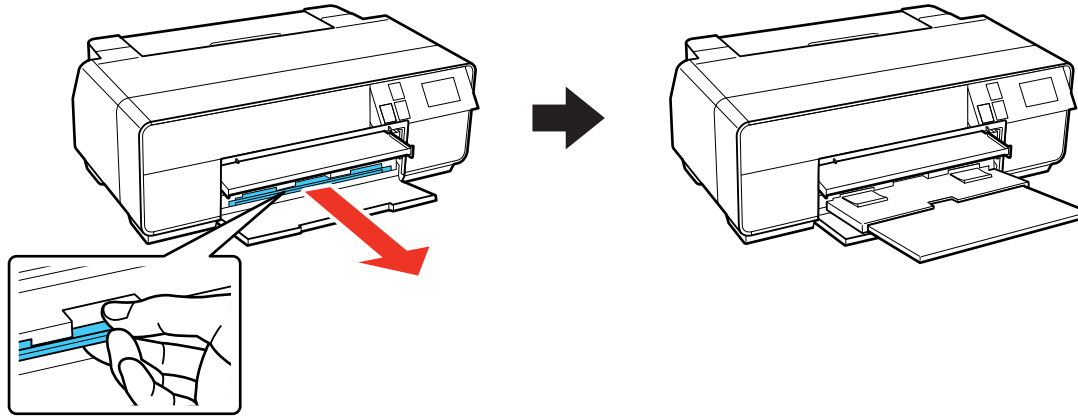

5. Remove any tape and protective paper from the end of the roll. Make sure the paper is cut straight across to avoid paper feeding problems.

Note: Avoid touching the surface of your paper. With canvas media that you have previously loaded, cut the edge straight each time you reload it for best results.

6. Place the roll paper holders on each end of the paper roll as shown. The holders are labeled L and R (for left and right), as viewed from the front of the printer.

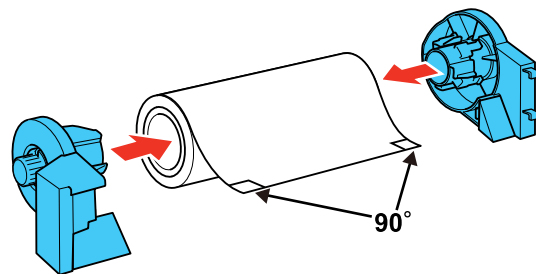

7. Open the rear paper support but do not extend it.

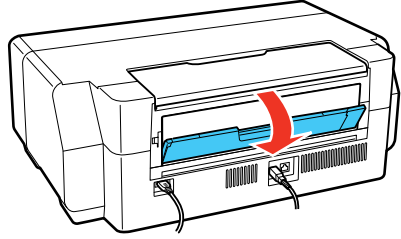

8. Attach the roll paper holders as shown. Hook the holders onto the attachment points marked with orange labels.

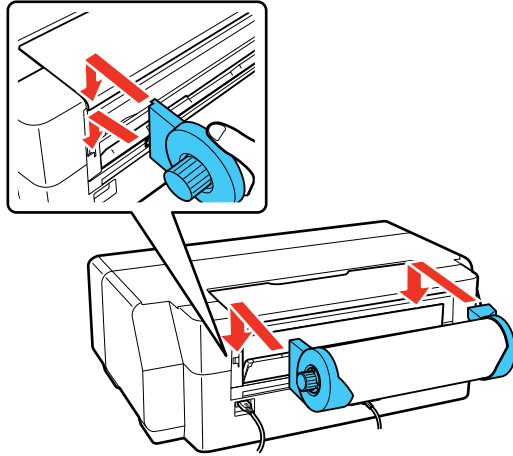

Note: Make sure the roll paper holders are firmly secured to your product.

9. Feed the paper into your product until it meets resistance. In a few seconds, the paper loads automatically.

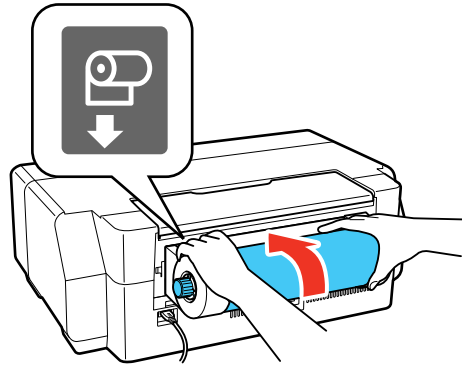

Note: When loading canvas media, leave slack in the roll as it feeds and prints for the best results.

10. When prompted by the product's touch screen, select the size and type of the paper you loaded and select **OK**.

[Cutting and Removing Roll Paper](#)

Parent topic: [Loading Media](#)

Related references

[Borderless Paper Type Compatibility](#)

Related tasks

[Selecting the Paper Settings for Each Source - Control Panel](#)

Cutting and Removing Roll Paper

After printing on roll paper, use scissors as described here to cut the roll paper from your printout.

1. When printing is finished, you see this screen:

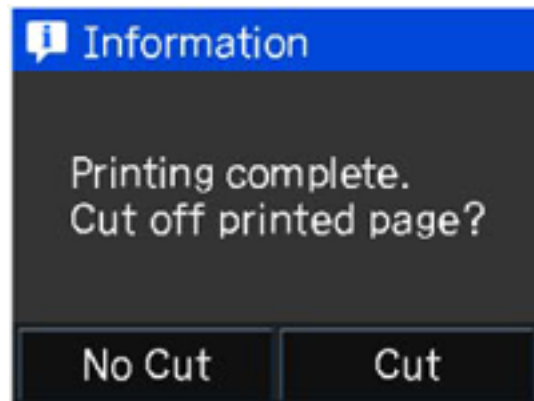

2. Select **Cut** to print a cut line and feed the paper.

Note: If you select **No Cut**, you return to the main screen.

3. Use scissors to cut the paper along the cut line.

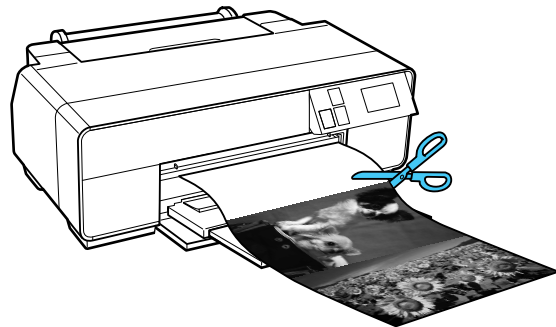

- Follow the instructions on the screen to unload the roll paper. Turn the knobs on the roll paper holders backward as the paper unloads, then remove the paper and holders from your product.

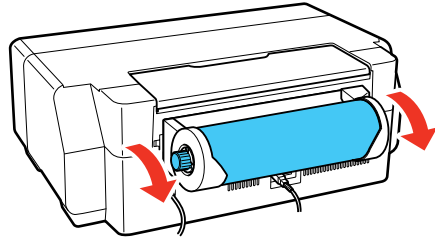

Note: You can also unload roll paper by selecting **Cut/Eject > Eject** on the touch screen.

Parent topic: [Loading Roll Paper](#)

Cut Sheet Media Loading Capacity

You can load cut sheet media in the paper types and quantities listed here into your product.

Sheet Feeder

Paper type	Loading capacity
Plain paper	120 sheets
Epson Presentation Paper Matte	100 sheets Letter (8.5 × 11 inches [216 × 279 mm]) 50 sheets B4 (13.9 × 9.84 inches [353 × 250 mm]), B5 (7.2 × 10.1 inches [182 × 257 mm]), 13 × 19 inches (330 × 483 mm)
Epson Bright White Paper	80 sheets
Epson Photo Paper Glossy	30 sheets

Paper type	Loading capacity
Epson Premium Photo Paper Glossy Epson Ultra Premium Photo Paper Glossy	30 sheets 4 × 6 inches (102 × 152 mm), 8 × 10 inches (203 × 254 mm), Letter (8.5 × 11 inches [216 × 279 mm]), 11 × 14 inches (279 × 356 mm) 20 sheets 5 × 7 inches (127 × 178 mm) 10 sheets A3 (11.7 × 16.5 inches [297 × 420 mm]), B4 (13.9 × 9.84 inches [353 × 250 mm]), B5 (7.2 × 10.1 inches [182 × 257 mm]), 13 × 19 inches (330 × 483 mm)
Epson Ultra Premium Photo Paper Luster Epson Ultra Premium Presentation Paper Matte	30 sheets Letter (8.5 × 11 inches [216 × 279 mm]) 10 sheets A3 (11.7 × 16.5 inches [297 × 420 mm]), 13 × 19 inches (330 × 483 mm)
Epson Metallic Photo Paper Glossy Epson Metallic Photo Paper Luster	30 sheets Letter (8.5 × 11 inches [216 × 279 mm]) 10 sheets 13 × 19 inches (330 × 483 mm)
Epson Premium Photo Paper Semi-gloss	30 sheets 4 × 6 inches (102 × 152 mm), Letter (8.5 × 11 inches [216 × 279 mm]) 10 sheets 13 × 19 inches (330 × 483 mm)
Epson Premium Presentation Paper Matte Epson Premium Presentation Paper Matte Double-sided	30 sheets 8 × 10 inches (203 × 254 mm), Letter (8.5 × 11 inches [216 × 279 mm]) 10 sheets 11 × 14 inches (279 × 356 mm), A3 (11.7 × 16.5 inches [297 × 420 mm]), 13 × 19 inches (330 × 483 mm)
Epson Photo Quality Self-adhesive Sheets	1 sheet

Manual Feed Tray

You can load one sheet of posterboard or other thick media 0.028 to 0.051 inch (0.7 to 1.3 mm) thick in this size in the front manual feed tray: 13 × 19 inches (330 × 483 mm). You can also load one sheet of the following types of media:

- Epson Velvet Fine Art Paper

- Epson UltraSmooth Fine Art Paper
- Epson Watercolor Paper Radiant White
- Epson Exhibition Fiber Paper
- Epson Exhibition Watercolor Paper Textured
- Epson Hot Press Bright
- Epson Hot Press Natural
- Epson Cold Press Bright
- Epson Cold Press Natural
- Epson Exhibition Canvas Matte

Parent topic: [Loading Media](#)

Available Epson Papers

You can purchase genuine Epson ink and paper at epson.com/ink3 (U.S. sales) or epson.ca (Canadian sales). You can also purchase supplies from an Epson authorized reseller. To find the nearest one, call 800-GO-EPSON (800-463-7766).

Note: Paper/media availability varies by country.

Paper Type	Size	Part number	Sheet count
Epson Bright White Paper	Letter (8.5 × 11 inches [216 × 279 mm])	S041586	500
Epson High Quality Ink Jet Paper	Letter (8.5 × 11 inches [216 × 279 mm])	S041111	100
Epson Cold Press Bright	Letter (8.5 × 11 inches [216 × 279 mm])	S042307	25
	13 × 19 inches (330 × 483 mm)	S042310	25
Epson Cold Press Natural	Letter (8.5 × 11 inches [216 × 279 mm])	S042297	25
	13 × 19 inches (330 × 483 mm)	S042300	25

Paper Type	Size	Part number	Sheet count
Epson Velvet Fine Art Paper	Letter (8.5 × 11 inches [216 × 279 mm])	S041636	20
	13 × 19 inches (330 × 483 mm)	S041637	20
Epson Exhibition Fiber Paper	Letter (8.5 × 11 inches [216 × 279 mm])	S045033	25
	13 × 19 inches (330 × 483 mm)	S045037	25
Epson Hot Press Bright	Letter (8.5 × 11 inches [216 × 279 mm])	S042327	25
	13 × 19 inches (330 × 483 mm)	S042330	25
Epson Hot Press Natural	Letter (8.5 × 11 inches [216 × 279 mm])	S042317	25
	13 × 19 inches (330 × 483 mm)	S042320	25
Epson Exhibition Watercolor Paper Textured	Letter (8.5 × 11 inches [216 × 279 mm])	S045486	25
	13 × 19 inches (330 × 483 mm)	S045487	20
Epson Brochure & Flyer Paper Matte Double-sided	Letter (8.5 × 11 inches [216 × 279 mm])	S042384	150
Epson (Consumer) Sample Media Pack	Various sizes	SMP603	Various quantities
Epson Photo Quality Self-adhesive Sheets	A4 (8.3 × 11.7 inches [210 × 297 mm])	S041106	10
Photo Quality Ink Jet Cards	A6 (4.1 × 5.8 inches [105 × 148 mm])	S041054	50
Epson Ultra Premium Photo Paper Glossy	Letter (8.5 × 11 inches [216 × 279 mm])	S042175	20
	8 × 10 inches (203 × 254 mm)	S041946	20

Paper Type	Size	Part number	Sheet count
Epson Premium Luster Photo Paper (260)	8.3 inches (211 mm) × 32 feet (9.8 m)	S041408	1 roll
	13 inches (330 mm) × 32 feet (9.8 m)	S041409	1 roll
	10 inches (254 mm) × 100 feet (30.5 m)	S042077	1 roll
Epson Metallic Photo Paper Glossy	Letter (8.5 × 11 inches [216 × 279 mm])	S045589	25
	13 × 19 inches (330 × 483 mm)	S045590	25
Epson Metallic Photo Paper Luster	Letter (8.5 × 11 inches [216 × 279 mm])	S045516	25
	13 × 19 inches (330 × 483 mm)	S045517	25
Epson Photo Paper Glossy	Letter (8.5 × 11 inches [216 × 279 mm])	S041649	50
	11 × 17 inches (279 × 432 mm)	S041156	20
	13 × 19 inches (330 × 483 mm)	S041143	20
	Letter (8.5 × 11 inches [216 × 279 mm])	S041271	100

Paper Type	Size	Part number	Sheet count
Epson Premium Photo Paper Glossy	Letter (8.5 × 11 inches [216 × 279 mm])	S041286	20
	A3 (11.7 × 16.5 inches [297 × 420 mm])	S041288	20
	13 × 19 inches (330 × 483 mm)	S041289	20
	Letter (8.5 × 11 inches [216 × 279 mm])	S041667	50
	11 × 17 inches (279 × 432 mm)	S041290	20
	4 × 6 inches (102 × 152 mm)	S041727	100
	5 × 7 inches (127 × 178 mm)	S041464	20
	8 × 10 inches (203 × 254 mm)	S041465	20
	11 × 14 inches (279 × 356 mm)	S041466	20
Epson Premium Photo Paper Semi-gloss	4 × 6 inches (102 × 152 mm)	S041982	40
	Letter (8.5 × 11 inches [216 × 279 mm])	S041331	20
	13 × 19 inches (330 × 483 mm)	S041327	20
	8 × 10 inches (203 × 254 mm)	S041467	50
	Letter (8.5 × 11 inches [216 × 279 mm])	S041257	50
	11 × 14 inches (279 × 356 mm)	S041468	50
	A3 (11.7 × 16.5 inches [297 × 420 mm])	S041260	50
	13 × 19 inches (330 × 483 mm)	S041263	50

Paper Type	Size	Part number	Sheet count
Epson Premium Presentation Paper Matte Double-sided	Letter (8.5 × 11 inches [216 × 279 mm])	S041568	50
Epson Premium Presentation Paper Matte	Letter (8.5 × 11 inches [216 × 279 mm])	S041062	100
	Legal (8.5 × 14 inches [216 × 356 mm])	S041067	100
	11 × 17 inches (279 × 432 mm)	S041070	100
	13 × 19 inches (330 × 483 mm)	S041069	100
	16.5 × 23.4 inches (420 × 594 mm)	S041079	30
	17 × 22 inches (432 × 559 mm)	S041171	100
Epson Proofing Paper White Semimatte	13 × 19 inches (330 × 483 mm)	S045115	100
	13 inches (300 mm) × 100 feet (30.5 m)	S042002	1 roll
Epson Standard Proofing Paper Publication	13 inches (300 mm) × 100 feet (30.5 m)	S041996	1 roll
Epson Standard Proofing Paper Commercial	13 inches (300 mm) × 100 feet (30.5 m)	S042144	1 roll
Epson Signature Worthy Sample Pack	Letter (8.5 × 11 inches [216 × 279 mm])	S045234	14
Epson Standard Proofing Paper (240)	13 × 19 inches (330 × 483 mm)	S045115	100

Paper Type	Size	Part number	Sheet count
Epson Ultra Premium Photo Paper Luster	Letter (8.5 × 11 inches [216 × 279 mm])	S041405	50
	A3 (11.7 × 16.5 inches [297 × 420 mm])	S041406	50
	13 × 19 inches (330 × 483 mm)	S041407	50
	13 × 19 inches (330 × 483 mm)	S041604	100
	17 × 22 inches (432 × 559 mm)	S042084	25
	13 inches (330 mm) × 32.8 feet (10 m)	S041409	1 roll
Epson Ultra Premium Presentation Paper Matte	Letter (8.5 × 11 inches [216 × 279 mm])	S041341	50
	A3 (11.7 × 16.5 inches [297 × 420 mm])	S041343	50
	13 × 19 inches (330 × 483 mm)	S041339	50
	13 × 19 inches (330 × 483 mm)	S041605	100
	17 × 22 inches (432 × 559 mm)	S041908	100
Epson UltraSmooth Fine Art Paper	13 × 19 inches (330 × 483 mm)	S041896	25
	17 × 22 inches (432 × 559 mm)	S041897	25
Epson Watercolor Paper Radiant White	13 × 19 inches (330 × 483 mm)	S041351	20
Epson Exhibition Canvas Matte	13 inches (330 mm) × 20 feet (6.1 m)	S045255	1 roll

Paper Type	Size	Part number	Sheet count
Epson Exhibition Canvas Satin	13 inches (330 mm) × 20 feet (6.1 m)	S045248	1 roll
Epson Exhibition Canvas Gloss	13 inches (330 mm) × 20 feet (6.1 m)	S045241	1 roll
Epson Exhibition Canvas Natural Matte	13 inches (330 mm) × 20 feet (6.1 m)	S045241	1 roll
Epson Exhibition Canvas Natural Satin	13 inches (330 mm) × 20 feet (6.1 m)	S045396	1 roll
Epson Exhibition Canvas Natural Gloss	13 inches (330 mm) × 20 feet (6.1 m)	S045410	1 roll

Parent topic: [Loading Media](#)

Borderless Paper Type Compatibility

You can print borderless photos on compatible paper types in compatible sizes.

Borderless Paper Types

- Epson Brochure & Flyer Paper Matte Double-sided
- Epson Ultra Premium Presentation Paper Matte
- Epson Premium Presentation Paper Matte
- Epson Premium Presentation Paper Matte Double-sided
- Epson Ultra Premium Photo Paper Glossy
- Epson Premium Photo Paper Semi-gloss
- Epson Ultra Premium Photo Paper Luster
- Epson Velvet Fine Art Paper
- Epson Watercolor Paper Radiant White
- Epson UltraSmooth Fine Art Paper 325 gsm
- Epson Premium Photo Paper Glossy
- Epson Photo Paper Glossy

Borderless Paper Sizes

- 4 × 6 inches (102 × 152 mm)
- 5 × 7 inches (127 × 178 mm)
- 8 × 10 inches (203 × 254 mm)
- Letter (8.5 × 11 inches [216 × 279 mm])
- 11 × 14 inches (279 × 356 mm)
- A4 (8.3 × 11.7 inches [210 × 297 mm])
- A3 (11.7 × 16.5 inches [297 × 420 mm])
- 13 × 19 inches (330 × 483 mm)

Parent topic: [Loading Media](#)

Paper or Media Type Settings - Product Software

For this paper	Select this Paper Type or Media Type setting
Plain paper Epson Bright White Paper	Plain Paper/Bright White Paper
Epson Premium Photo Paper Glossy Epson Ultra Premium Photo Paper Glossy	Premium Photo Paper Glossy
Epson Photo Paper Glossy	Photo Paper Glossy
Epson Presentation Paper Matte	Presentation Paper Matte
Epson Premium Photo Paper Semi-gloss	Premium Photo Paper Semigloss
Premium Luster Photo Paper (260) Epson Ultra Premium Photo Paper Luster	UltraPremium Photo Paper Luster
Epson Ultra Premium Presentation Paper Matte	Ultra Premium Presentation Paper Matte
Epson Premium Presentation Paper Matte Epson Premium Presentation Paper Matte Double-sided Epson Brochure & Flyer Paper Matte Double-sided Epson Photo Quality Self-adhesive Sheets	Premium Presentation Paper Matte

For this paper	Select this Paper Type or Media Type setting
Epson Velvet Fine Art Paper	Velvet Fine Art Paper
Epson Metallic Photo Paper Glossy	Metallic Photo Glossy
Epson Metallic Photo Paper Luster	Metallic Photo Luster
Epson Hot Press Bright	Hot Press Bright
Epson Hot Press Natural	Hot Press Natural
Epson Cold Press Bright	Cold Press Bright
Epson Cold Press Natural	Cold Press Natural
Epson Exhibition Fiber Paper	Exhibition Fiber Paper
Epson Exhibition Watercolor Paper Textured	Exhibition Watercolor Textured
Epson Watercolor Paper Radiant White	Watercolor Paper - Radiant White
Epson UltraSmooth Fine Art Paper Epson UltraSmooth Fine Art Paper 325 gsm	UltraSmooth Fine Art Paper
Standard Proofing Paper (240) Proofing Paper White Semimatte Standard Proofing Paper Publication Standard Proofing Paper Commercial	UltraPremium Photo Paper Luster
Epson Exhibition Canvas Matte	Exhibition Canvas Matte
Epson Exhibition Canvas Satin	Exhibition Canvas Satin
Epson Exhibition Canvas Gloss	Exhibition Canvas Gloss
Epson Exhibition Canvas Natural Matte	Exhibition Canvas Natural Matte
Epson Exhibition Canvas Natural Satin	Exhibition Canvas Natural Satin
Epson Exhibition Canvas Natural Gloss	Exhibition Canvas Natural Gloss
Ink jet printable CD or DVD	CD/DVD or CD/DVD Premium Surface (front manual feed tray only)
Posterboard	Ultra Premium Presentation Paper Matte (front manual feed tray only)

Parent topic: [Loading Media](#)

Selecting the Paper Settings for Each Source - Control Panel

You can change the default paper size and paper type for each source using the control panel on the product.

1. Press the  home button, if necessary.
2. Select **Load Guide**.
3. Select the paper source you want to change.
4. Select **Paper Size**.
5. Select the paper size you loaded.
6. Select **Paper Type**.
7. Select the paper type for the paper you loaded following the guidelines in the link here.
8. Select **OK**.
9. Repeat these steps to select another paper source to change.

[Paper or Media Type Settings - Control Panel](#)

Parent topic: [Loading Media](#)

Paper or Media Type Settings - Control Panel

For this paper	Select this Paper Type setting
Plain paper Epson Bright White Paper	Plain Paper
Epson Premium Photo Paper Glossy Epson Ultra Premium Photo Paper Glossy	Prem. Glossy
Epson Photo Paper Glossy	Glossy
Epson Presentation Paper Matte	Presentation Matte
Epson Premium Photo Paper Semi-gloss	Prem. Semigloss
Premium Luster Photo Paper (260) Epson Ultra Premium Photo Paper Luster	Premium Luster
Epson Ultra Premium Presentation Paper Matte	Ultra Premium Matte

For this paper	Select this Paper Type setting
Epson Premium Presentation Paper Matte Epson Premium Presentation Paper Matte Double-sided Epson Brochure & Flyer Paper Matte Double-sided Epson Photo Quality Self-adhesive Sheets	Presentation Matte
Epson Velvet Fine Art Paper	Velvet Fine Art
Epson Metallic Photo Paper Glossy	Prem. Glossy
Epson Metallic Photo Paper Luster	Premium Luster
Epson Hot Press Bright Epson Hot Press Natural Epson Cold Press Bright Epson Cold Press Natural	UltraSmooth Fine Art
Epson Exhibition Fiber Paper	Premium Luster
Epson Exhibition Watercolor Paper Textured Epson Watercolor Paper Radiant White	Watercolor Paper
Epson UltraSmooth Fine Art Paper Epson UltraSmooth Fine Art Paper 325 gsm	UltraSmooth Fine Art
Standard Proofing Paper (240) Proofing Paper White Semimatte Standard Proofing Paper Publication Standard Proofing Paper Commercial	Prem. Semigloss
Epson Exhibition Canvas Matte Epson Exhibition Canvas Natural Matte	UltraSmooth Fine Art
Epson Exhibition Canvas Satin Epson Exhibition Canvas Gloss Epson Exhibition Canvas Natural Satin Epson Exhibition Canvas Natural Gloss	Premium Luster



For this paper	Select this Paper Type setting
Ink jet printable CD or DVD	CD/DVD
Posterboard	UltraSmooth Fine Art

Parent topic: [Selecting the Paper Settings for Each Source - Control Panel](#)

Selecting the Default Paper Setup Display and Error Notice Settings

You can select default paper setup display and error notice settings that apply to all print jobs using the control panel on your product.

Note: These settings can be locked by an administrator. If you cannot access these settings, contact your administrator for assistance.

1. Press the  home button, if necessary.
2. Press the  setup button.

You see a screen like this:

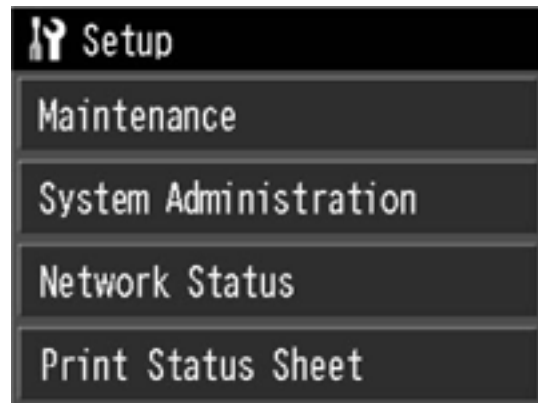

3. Select **System Administration**. Enter the administrator password, if necessary.
4. Select **Printer Settings**.
5. Select **Paper Source Settings**.
6. Select **Paper Setup Display**.

7. Select one of these options:

- Select **On** to display the media setup screen when paper is loaded.
- Select **Off** if you do not want the media setup screen displayed when paper is loaded.

Note: When this setting is off, AirPrint is unavailable.

8. Select **Error Notice**.

9. Select one of these options:

- Select **On** to display an error if the loaded paper size or paper type differs from the product settings.
- Select **Off** if you do not want an error to display.

Note: This setting is turned off automatically if you set the **Paper Setup Display** setting to **Off**.

10. When you are finished, press the  home button to exit.

Parent topic: [Loading Media](#)

Printing from a Computer

Before printing from your computer, make sure you have set up your product and installed its software as described on the *Start Here* sheet.

Note: If you have an Internet connection, it is a good idea to check for updates to your product software on Epson's support website. If you see a Software Update screen, select **Enable automatic checking** and click **OK**. The update scans your system to see if you have the latest product software. Follow the on-screen instructions.

[Printing with Windows](#)

[Printing with OS X](#)

Printing with Windows

You can print with your product using any Windows application, as described in these sections.

[Selecting Basic Print Settings - Windows](#)

[Selecting Print Layout Options - Windows](#)

[Selecting Additional Settings - Windows](#)

[Printing Your Document or Photo - Windows](#)

[Saving, Sharing, and Customizing the Printer Settings](#)

[Selecting Default Print Settings - Windows](#)

[Changing the Language of the Printer Software Screens](#)

[Changing Automatic Update Options](#)

Parent topic: [Printing from a Computer](#)

Selecting Basic Print Settings - Windows

Select the basic settings for the photo or document you want to print.

1. Open a photo or document for printing.
2. Select the print command in your application.

Note: You may need to select a print icon on your screen, the **Print** option in the File menu, or another command. See your application's help utility for details.

3. If necessary, select your product name as the printer you want to use.

Note: You may also need to select **Properties** or **Preferences** to view your print settings.

You see the Main tab of your printer settings window:

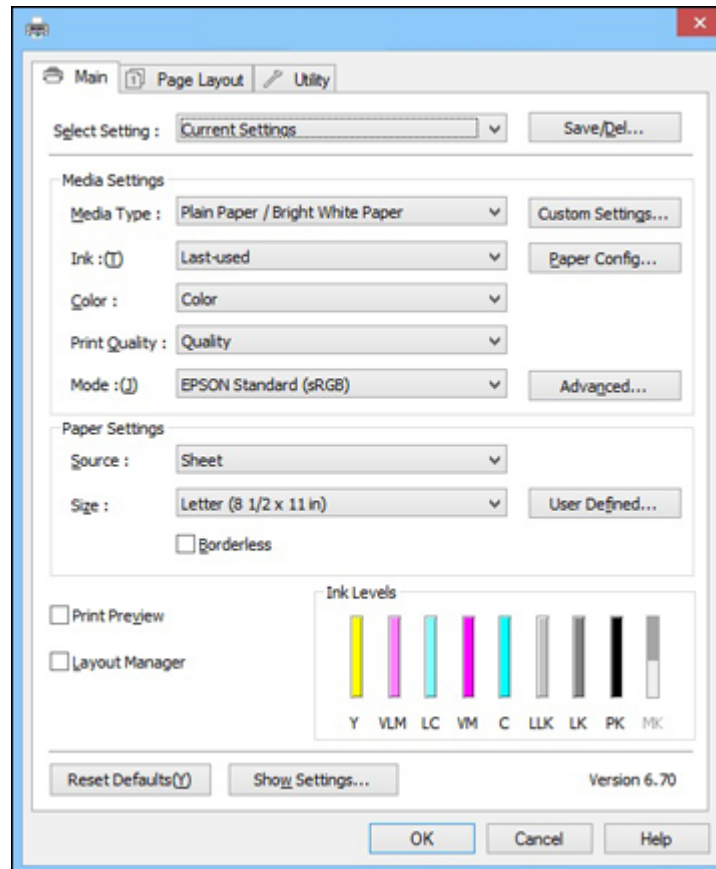

4. Select the **Media Type** setting that matches the paper you loaded.
5. If you are using non-Epson paper or media and you need to fine-tune its performance, click the **Paper Config** button and adjust paper configuration options as necessary.

6. When using plain paper, select an **Ink** option:
 - To print using the previous print job's setting, select **Last-Used**.
 - Select the **Photo Black Ink** or **Matte Black Ink** setting according to the media type you are using.

Note: To avoid changing black ink more often than necessary, you can set the default black ink type to the one you usually use. See the link at the end of these steps.

7. Select a **Color** option:
 - To print a color document or photo, select the **Color** setting.
 - To print text and graphics in black or shades of gray, select the **Advanced B&W Photo** or **Grayscale** setting.

Note: The **Grayscale** setting is only available when plain paper is selected as the **Media Type**.

8. For the **Print Quality** setting, select **Speed**, **Quality**, or **Max Quality**, or select **Quality Options** and choose the quality option that matches the print quality you want to use.
9. Select the desired color management option as the **Mode** setting.
10. Select the **Source** setting that matches the paper feeding method you are using.
11. Select the size of the paper you loaded as the **Size** setting.

Note: You can also select the **User-Defined** setting to create a custom paper size.

12. If you want to print a photo without borders, select **Borderless**.

Note: You must select a compatible borderless paper type and size to print without borders. Check the borderless paper compatibility list for details.

13. To see a preview of how your document or photo will print, select **Print Preview**. (The preview appears after you click **Print** but before printing starts.)
14. To layout multiple print jobs for printing all at once, select **Layout Manager**.

[Paper Configuration Options - Windows](#)

[Advanced B&W Photo Options - Windows](#)

[Print Quality Options - Windows](#)

[Color Management Options - Windows](#)

[Advanced Color Controls - Windows](#)
[Paper Source Options - Windows](#)
[Using Layout Manager - Windows Only](#)

Parent topic: [Printing with Windows](#)

Related concepts

[Switch Black Ink Type](#)

Related references

[Double-sided Printing Options - Windows](#)

[Black Ink Type Media List](#)

Related tasks

[Printing Your Document or Photo - Windows](#)

Paper Configuration Options - Windows

Select any of the available Paper Configuration options to fine-tune the quality of your print.

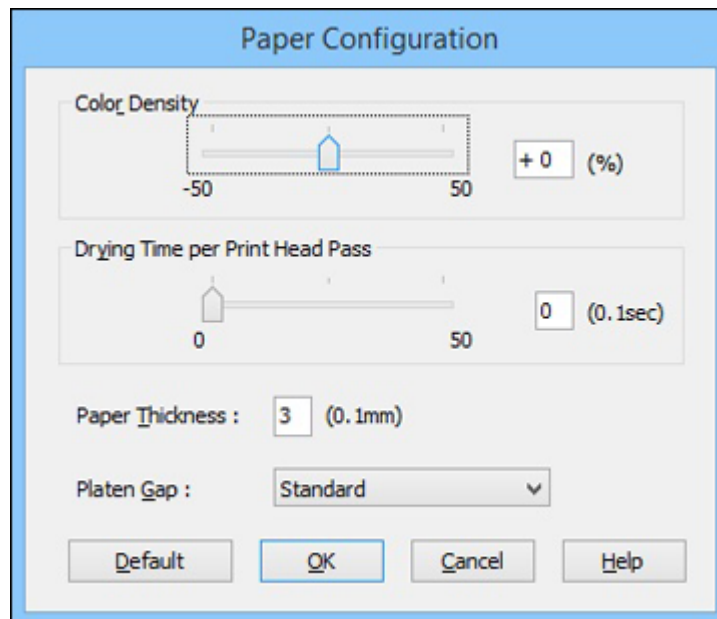

Color Density

Adjusts the ink saturation level.

Drying Time per Print Head Pass

Pauses print head movement for up to 5 seconds after each pass to allow ink to dry. This lets you print with non-Epson media and avoid smearing the ink.

Paper Thickness

Lets you select the thickness of your paper or media.

Platen Gap

Adjusts the distance from the paper to the print head. (Use a wider setting if you are seeing edge marks or scuffs on your prints.)

Parent topic: [Selecting Basic Print Settings - Windows](#)

Advanced B&W Photo Options - Windows

If you select **Advanced B&W Photo** as the Color option, you can easily produce neutral and toned black-and-white prints. Whether your photo is color or grayscale, you can use this screening and color management technology to create stunning black-and-white prints. You can select any of the available options.

Color Toning

Adds tone (hue) to your black-and-white output. The default is **Neutral**, which provides a neutral tonal scale print. You can also choose other popular presets such as **Cool**, **Warm**, and **Sepia**. Note that the presets affect the target found in the tone color circle.

Tone

Changes the entire tonal scale of your black-and-white output. While **Darker** is the default setting, you may see better results if you choose **Dark**. The tone color circle adjusts the hue of your black-and-white print. Click on any portion of the color wheel or enter corresponding values to customize the tone (hue) to add to your print. The closer you select to the edge of the wheel, the more color you add.

Brightness

Adjusts the overall lightness and darkness of your image.

Contrast

Adjusts the difference between the light and dark areas of your image.

Shadow Tonality

Controls tonality only in the shadow areas of your image.

Highlight Tonality

Controls tonality only in the highlight areas of your image.

Max Optical Density

Adjusts the overall density or focus of the print. Create a soft focus print by lowering the density setting.

Highlight Point Shift

Helps reduce gloss differential on glossy media by adding density to the highlights of your image.

Parent topic: [Selecting Basic Print Settings - Windows](#)

Print Quality Options - Windows

You can use the Speed/Quality slider to set the desired quality level, and select any of the available Quality options to fine-tune the quality of your print. Some settings may be unavailable, depending on the paper type and border setting you have chosen.

High Speed

Speeds up printing but may reduce print quality.

Edge Smoothing

Smooths jagged edges in low-resolution images such as screen captures or images from the Web.

Finest Detail

Sharpens edges on vector-based data including text, graphics, and line art. (This setting does not affect photographs.)

Parent topic: [Selecting Basic Print Settings - Windows](#)

Color Management Options - Windows

You can adjust the **Mode** setting to fine-tune the colors in your printout, or turn off color management in your printer software.

EPSON Standard (sRGB)

Increases the contrast in images. Click the **Advanced** button to use advanced color controls.

Adobe RGB

Matches image colors to the Adobe RGB color standard. Use this setting if your source file was captured in Adobe RGB. Click the **Advanced** button to use advanced color controls.

PhotoEnhance

Lets you choose from various Scene Correction settings to automatically analyze your photos.

Note: PhotoEnhance uses a sophisticated face recognition technology to optimize photos that include faces. For this to work, both eyes and the nose must be visible in the subject's face. If your photo includes a face with an intentional color cast, such as a statue, you may want to turn off **PhotoEnhance** to retain the special color effects.

ICM

Automatically adjusts colors based on the printer's ICC profile and the selected **Media Type** setting, using the Image Color Matching system. Click the **Advanced** button to choose the input profile and other settings.

Note: In most cases, you get better results by applying color management in your application, rather than in the printer driver.

Off (No Color Adjustment)

Turns off color management in your printer software so you can manage color using only your application software.

Note: An ICC profile is required if color management is turned off.

Parent topic: [Selecting Basic Print Settings - Windows](#)

Advanced Color Controls - Windows

If you selected **EPSON Standard (RGB)** or **Adobe RGB** as the **Mode** setting, you can click the **Advanced** button to select detailed settings.

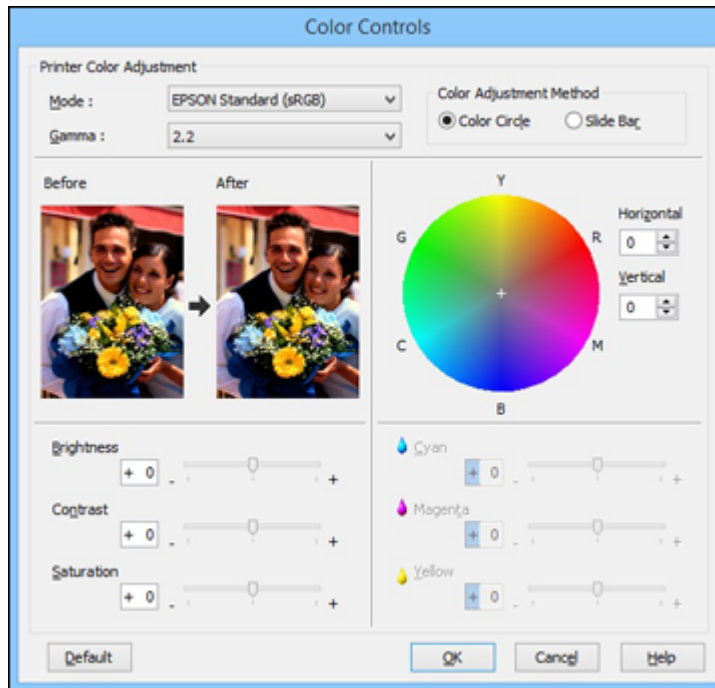

The Color Controls screen lets you specify values for adjusting brightness, contrast, saturation, and individual Cyan, Magenta, and Yellow color tones. You can choose from two Printer Color Adjustment modes and two Gamma settings, and use either a color circle or slide bar to adjust color.

Parent topic: [Selecting Basic Print Settings - Windows](#)

Paper Source Options - Windows

You can select any of the available options in the paper Source menu to print on the paper loaded in that source.

Sheet

Selects sheets of paper loaded in the sheet feeder.

Roll Paper

Selects roll paper loaded in the roll paper holder for photos or panoramics up to 27 inches (68.6 cm) long. Click **Print page frame** to print a cutting guideline around each photo.

Roll Paper (Banner)

Selects roll paper loaded in the roll paper holder for photos or banners over 27 inches (68.6 cm) long.

Front - Fine Art

Selects fine art paper loaded in the front manual feed tray.

Front - Poster Board

Selects poster board or other thick media loaded in the front manual feed tray.

CD/DVD

Selects the CD or DVD loaded as the source.

Parent topic: [Selecting Basic Print Settings - Windows](#)

Using Layout Manager - Windows Only

Layout Manager lets you create a poster or display by dragging multiple pieces of print data created in different applications onto one sheet of paper for printing.

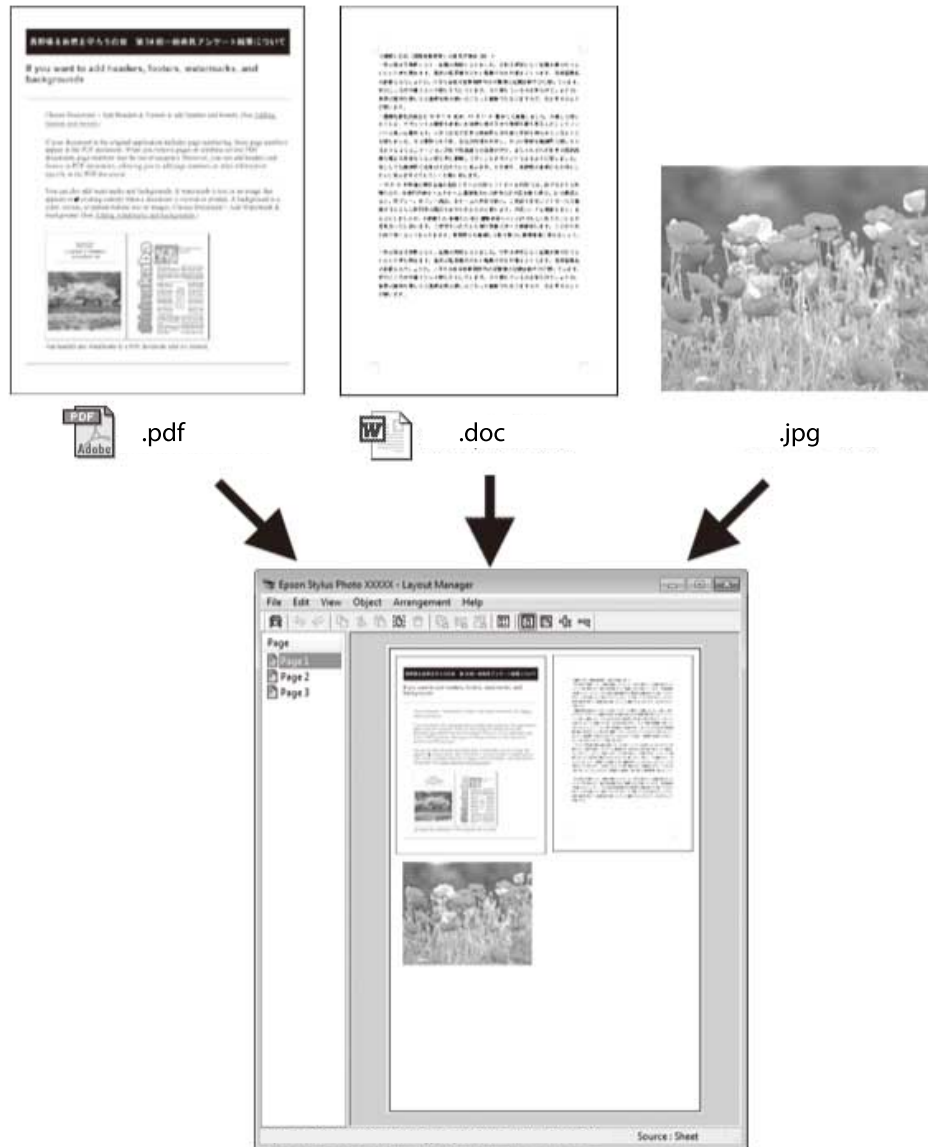

You can also place the same print data multiple times as shown here.

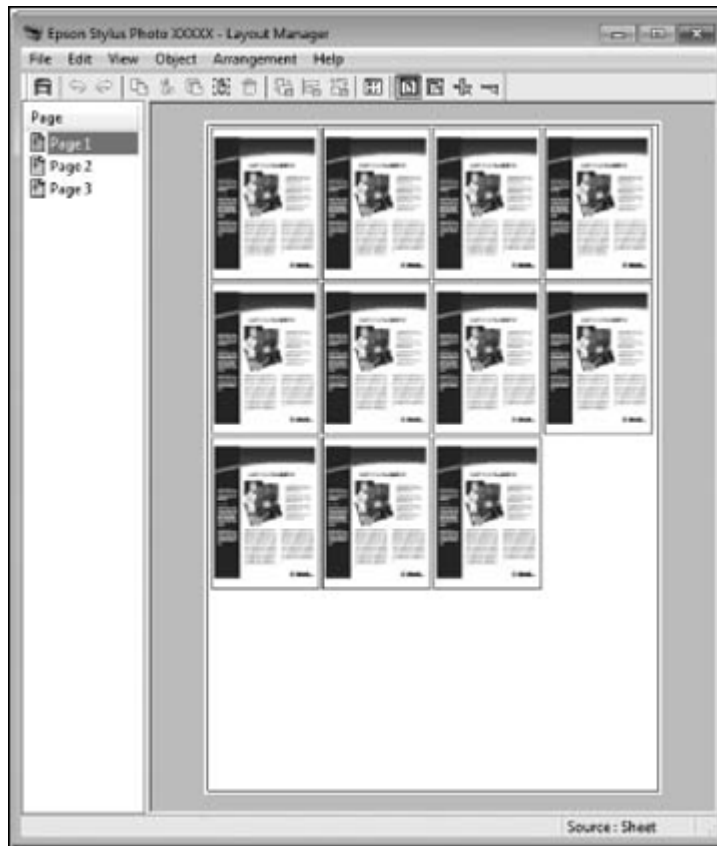

You can place print data in different sizes and orientations to maximize media usage, as shown here.

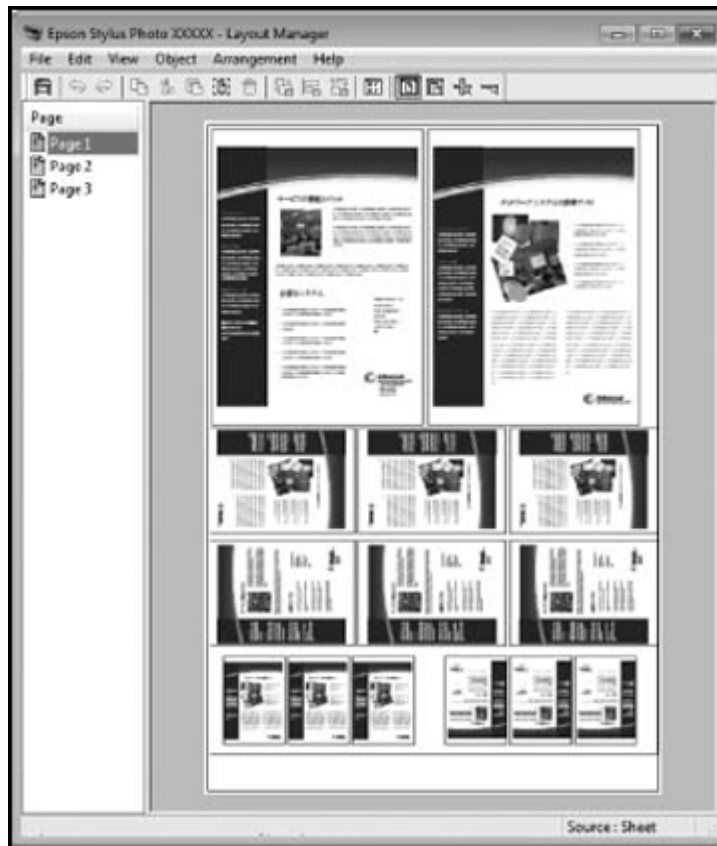

You can place print data on roll paper as shown here.

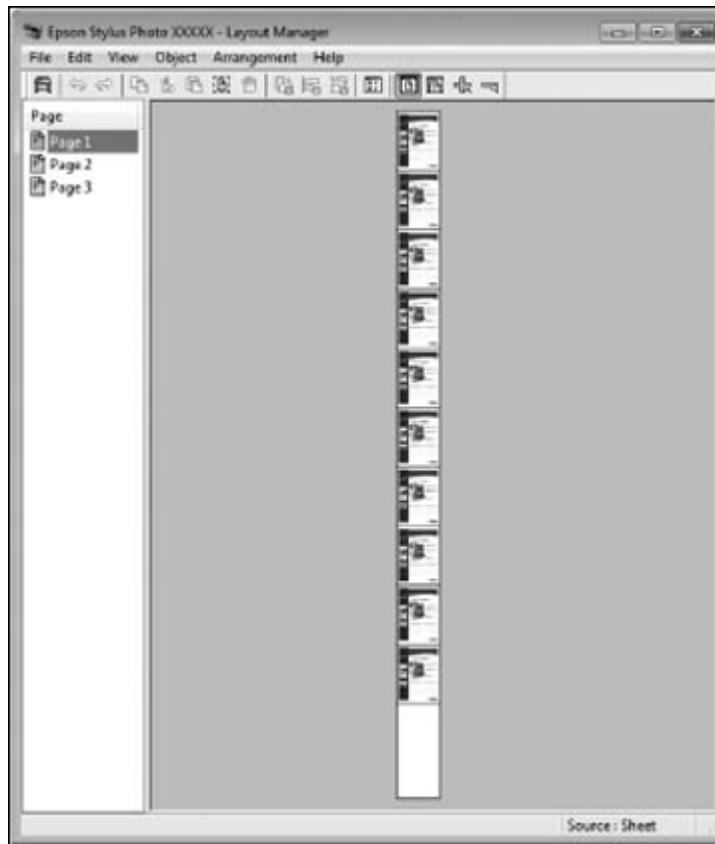

1. Open the file you want to print in your application.
2. Select the print command in your application.

3. Select **Layout Manager** on the Main tab and choose an option for the **Size** setting that matches the size of the document in the application.

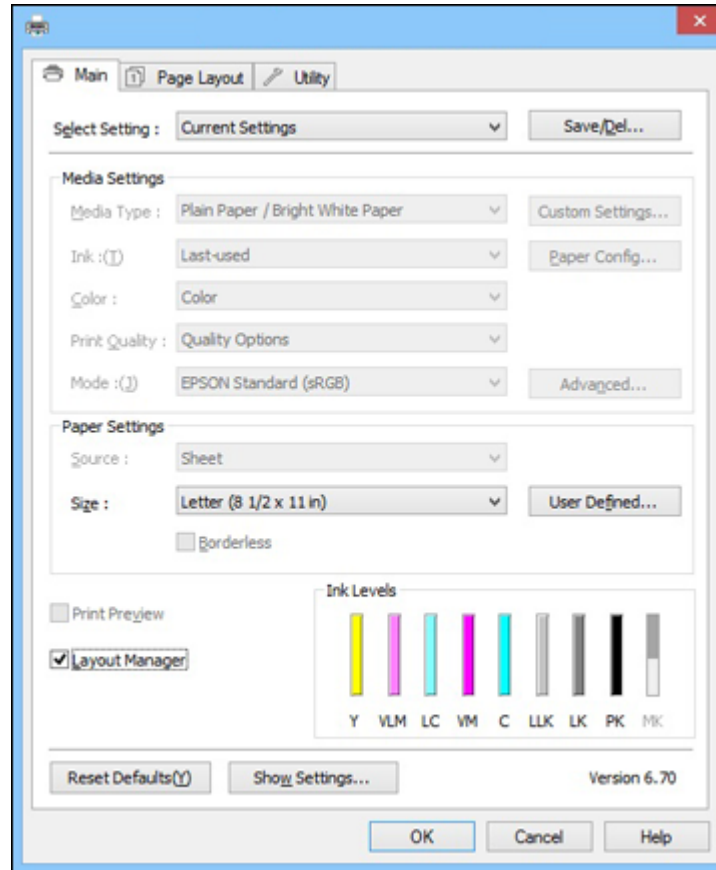

Note: You select the size of the paper you are printing on in a later step.

4. Click **OK** and then click **Print**, if necessary.
The Layout Manager screen opens and displays one page in the layout.
5. Leave the Layout Manager screen open and repeat steps 1 to 4 to arrange additional print data. The pages are added to the Layout Manager screen.

6. Do the following to arrange objects on the Layout Manager screen:
 - Drag pages to move and resize them.
 - Use the tool buttons and the Object menu to align and rotate pages.
 - Resize and replace whole pages in the Preference or Arrangement Settings screens.

Note: See the Layout Manager screen help for more details.

7. Click **File > Properties**, then select your print settings on the Main tab.
8. Click the **File** menu on the Layout Manager screen and click **Print**.

Note: To save the current job to a file, click the **File** menu on the Layout Manager screen, save the file, and close the Layout Manager screen. To open the saved file later for editing or reprinting, right-click the printer icon in the Windows taskbar, select Layout Manager, and open the file.

Parent topic: [Selecting Basic Print Settings - Windows](#)

Selecting Print Layout Options - Windows

You can select a variety of sizing and layout options for your document or photo on the Page Layout tab.

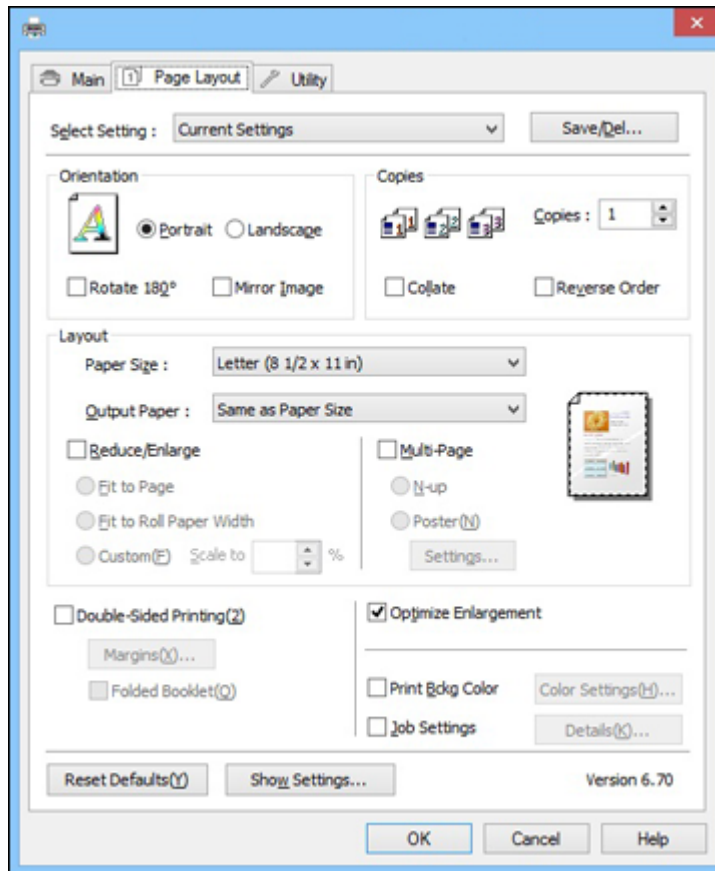

- To change the orientation of your printed document or photo, select the **Portrait** or **Landscape** checkbox.
- To rotate or flip the printed image, select the **Rotate 180°** or **Mirror Image** checkbox.
- To select multiple copies and their print order, select the **Copies**, **Collate**, and **Reverse Order** options.

- To change the size of your printed document or photo, select the **Reduce/Enlarge** checkbox and select sizing options.
- To print multiple pages on one sheet of paper, or print one image on multiple sheets of paper, select the **Multi-Page** checkbox and select the options you want.
- To print on both sides of your paper, select the **Double-Sided Printing** options.

Note: Your product software prompts you to reinsert your paper when it is time to print on the reverse side.

- To enlarge your image beyond the limits of your application program, select **Optimize Enlargement**.

Note: The driver can increase the image size up to 650% and decrease the output resolution to stay within the pixel limitations. Depending on the resolution of the original image and the print size, you may see reduced print quality.

- To print a color background on the page, select **Print Bckg Color** and click **Color Settings** to select the color you want to use.
- To print the time, date, and other information about your print job at the top or bottom of the page, select **Job Settings** and click **Details** to select the settings you want to use.

[Reduce/Enlarge Options - Windows](#)

[Multi-Page Printing Options - Windows](#)

[Double-sided Printing Options - Windows](#)

Parent topic: [Printing with Windows](#)

Reduce/Enlarge Options - Windows

You can select any of the Reduce/Enlarge options to size your printed image.

Fit to Page

Sizes your printed image to fit on the paper you loaded and selected as the Output Paper setting.

Fit to Roll Paper Width

Sizes your printed image to fit the width of the roll paper you loaded.

Custom

Sizes your printed image by the percentage you select as the **Scale to** setting.

Parent topic: [Selecting Print Layout Options - Windows](#)

Multi-Page Printing Options - Windows

You can select these Multi-Page options to set up your multi-page print job.

N-up

Prints 2 (**2-up**) or 4 (**4-up**) pages on one sheet of paper.

Poster

Prints one image on multiple sheets of paper to create a large poster with or without borders. Click the **Settings** button to select the layout and guideline options.

Parent topic: [Selecting Print Layout Options - Windows](#)

Double-sided Printing Options - Windows

You can select any of the double-sided options to set up your double-sided print job.

Margins

Click **Margins** to customize the margins used during double-sided printing.

Binding Edge Options

Select a setting that orients double-sided print binding in the desired direction.

Binding Margin Options

Select options that define a wider margin to allow for binding.

Folded Booklet Option

Select a binding option to use when creating a folded booklet.

Parent topic: [Selecting Print Layout Options - Windows](#)

Selecting Additional Settings - Windows

You can run maintenance utilities and select additional settings that apply to all the print jobs you send to your product.

1. Access the Windows Desktop and right-click the product icon in the Windows taskbar.
2. Select **Printer Settings**.
3. Click the **Utility** tab.

You see a window like this:

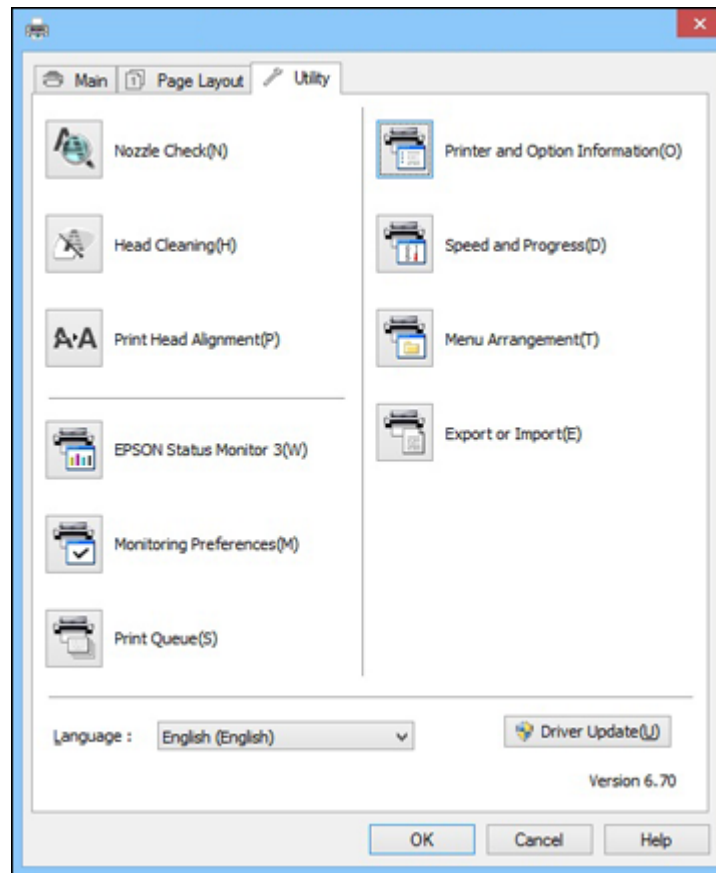

4. Select any of the following options, as necessary:
 - **Nozzle Check** to print a nozzle check pattern to check whether the print head nozzles are clogged.
 - **Head Cleaning** to clean the print head if you notice banding or gaps in your printouts.
 - **Print Head Alignment** to align the print head if printouts appear grainy or out of focus.
 - **Epson Status Monitor 3** to check the printer's status.

- **Monitoring Preferences** to select the error notifications displayed on the Epson Status Monitor 3 screen, or add a shortcut to the utility in the Windows taskbar.
 - **Print Queue** to display a list of all waiting print jobs, view information on the data waiting to be printed, and delete or reprint the jobs.
 - **Language** to select the language you want to use for the printer software screens.
 - **Printer and Option Information** to set the time to turn off the printer automatically.
 - **Speed and Progress** to select various printing options.
 - **Menu Arrangement** to arrange the **Setting**, **Media Type**, and **Paper Size** options by frequency of use.
 - **Export or Import** to save the print settings to a file or import them from a file. This is useful when you want to select the same print settings on multiple computers.
 - **Driver Update** to check the Epson website for any available printer software updates and install them automatically.
5. Click **OK** to close the printer software window.

Parent topic: [Printing with Windows](#)

Related tasks

[Printing Your Document or Photo - Windows](#)

Printing Your Document or Photo - Windows

Once you have selected your print settings, you are ready to save your settings and print.

1. Click **OK** to save your settings.

You see your application's Print window, such as this one:

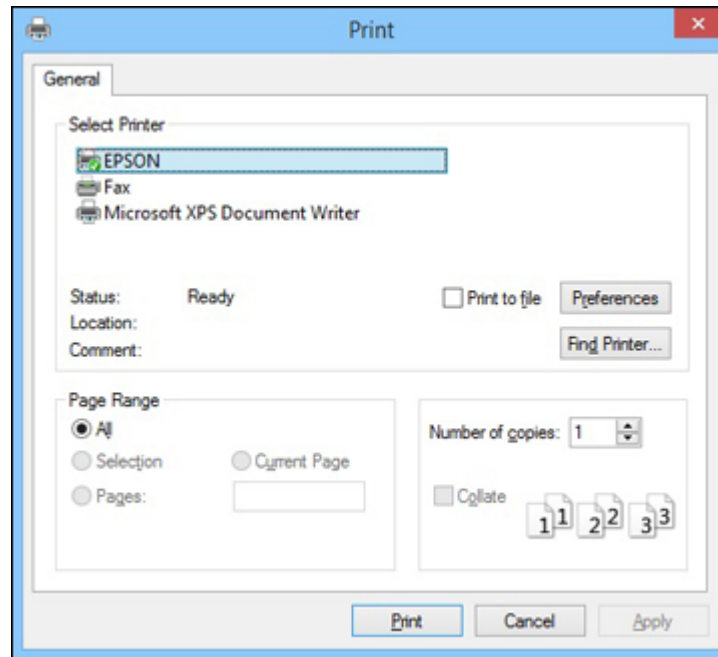

2. Click **OK** or **Print** to start printing.

[Checking Print Status - Windows](#)

Parent topic: [Printing with Windows](#)

Checking Print Status - Windows

During printing, you see this window showing the progress of your print job. It allows you to control printing and check ink cartridge status.

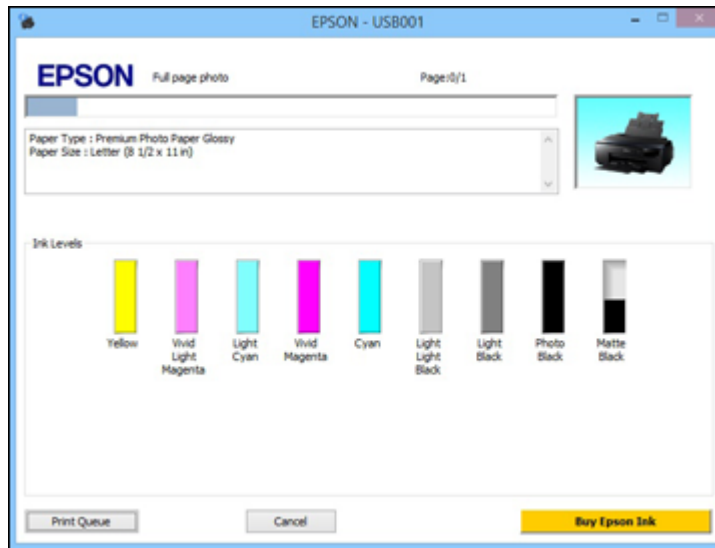

- To cancel printing, click **Cancel**.
- To see print jobs waiting to print, click **Print Queue**.

Parent topic: [Printing Your Document or Photo - Windows](#)

Saving, Sharing, and Customizing the Printer Settings

You can save groups of print settings or media settings so you can reuse them for future print jobs. You can export these settings as a file so you can share them with other users. You can also edit the settings displayed in the printer software screens.

[Saving and Sharing Print Settings - Windows](#)

[Saving and Sharing Media Settings - Windows](#)

[Editing Print Setting Displays - Windows](#)

Parent topic: [Printing with Windows](#)

Saving and Sharing Print Settings - Windows

You can save your print settings so you can use them for future print jobs.

1. Select the print settings you want to save.
2. Click **Save/Del** at the top of the Main or Page Layout tab in your printer software.

You see a window like this:

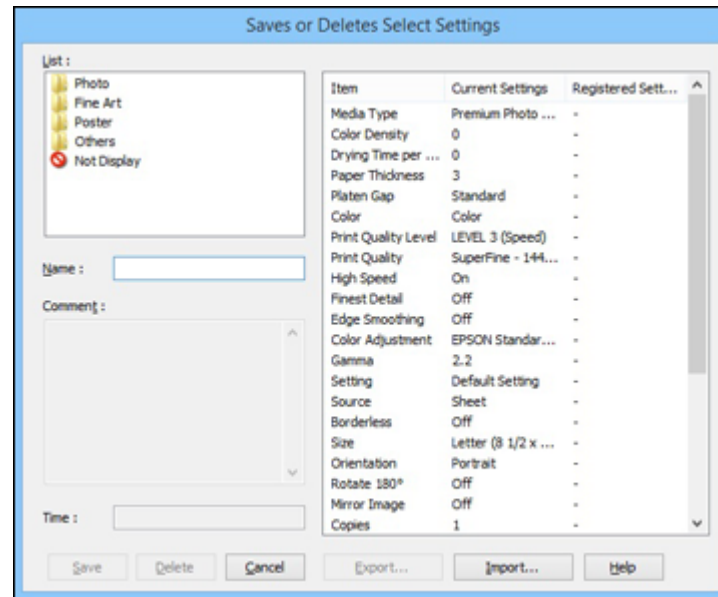

3. Verify that your settings are correct, enter a name for the group of settings in the **Name** field, and click **Save**.

Note: If you need to delete a group of settings you have created, select the name of the group of settings from the list and click **Delete**.

4. Do the following as necessary:
 - Select the name of the group of settings from the Select Setting list and use them to print.
 - To export the settings, click **Save/Del**, select the name of the group of settings, click **Export**, select a location, and enter a file name.

- To import a group of settings, click **Save/Del**, click **Import**, select the file you want to use, and click **Open**. Then use the settings to print.

Parent topic: [Saving, Sharing, and Customizing the Printer Settings](#)

Saving and Sharing Media Settings - Windows

You can save and share settings you have selected for a particular media type so you can use them for future print jobs.

1. Select the Media Settings you want to save on the Main tab, as necessary.
2. Click **Custom Settings**.

You see a window like this:

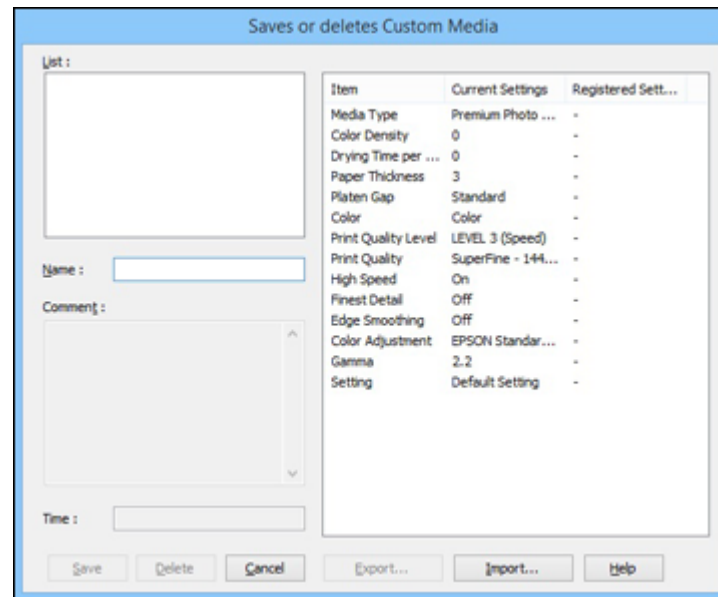

3. Verify that your settings are correct, enter a name for the media settings in the **Name** field, and click **Save**.

Note: If you need to delete a group of settings you have created, select the name of the settings from the list and click **Delete**.

4. Do the following as necessary:
 - Select the name of a media setting as the **Media Type** setting and use it to print.
 - To export the settings, click **Custom Settings**, select the name of the media settings, click **Export**, select a location, and enter a file name.
 - To import settings, click **Custom Settings**, select the name of the media settings, click **Import**, select the file you want to use, and click **Open**. Then use these settings to print.

Parent topic: [Saving, Sharing, and Customizing the Printer Settings](#)

Editing Print Setting Displays - Windows

You can arrange the displayed print settings so you can easily select the settings you use most often.

1. Click the **Utility** tab in the printer software.
2. Select **Menu Arrangement**.

You see this window:

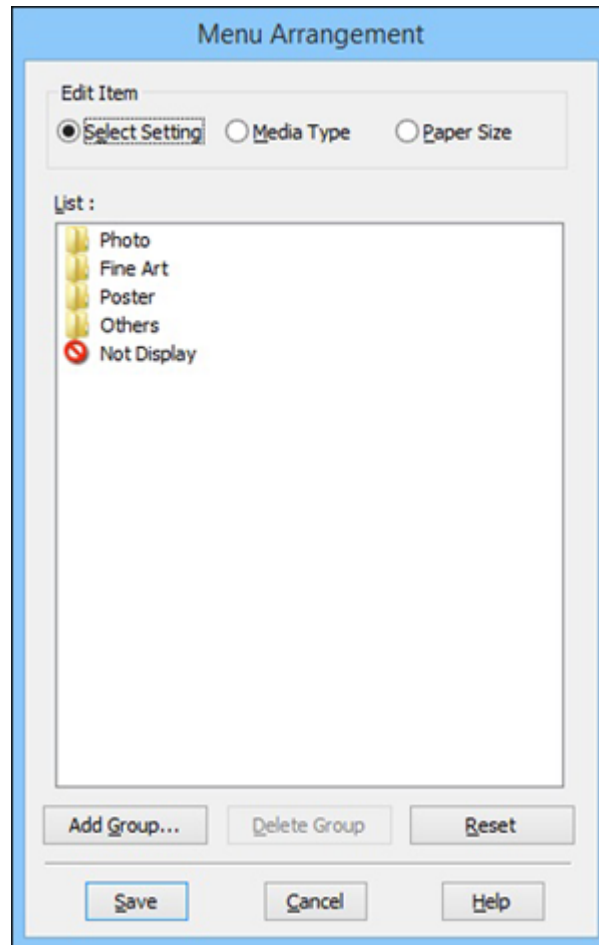

3. Select the item you want to edit.
4. Order or group items in the **List** box.
 - To move and reorder items, drag and drop them in the list.
 - To add a new group (folder), click **Add Group**.
 - To delete a group (folder), select the group and click **Delete Group**.

- To hide a group, drag and drop it to **Not Display**.

Note: If you delete a group, the group folder is deleted but the items within the folder remain.

5. Click **Save**.

Parent topic: [Saving, Sharing, and Customizing the Printer Settings](#)

Selecting Default Print Settings - Windows

When you change your print settings in a program, the changes apply only while you are printing in that program session. If you want to change the print settings you use in all your Windows programs, you can select new default print settings.

1. Access the Windows Desktop and right-click the product icon in the Windows taskbar.
2. Select **Printer Settings**.

You see the printer settings window:

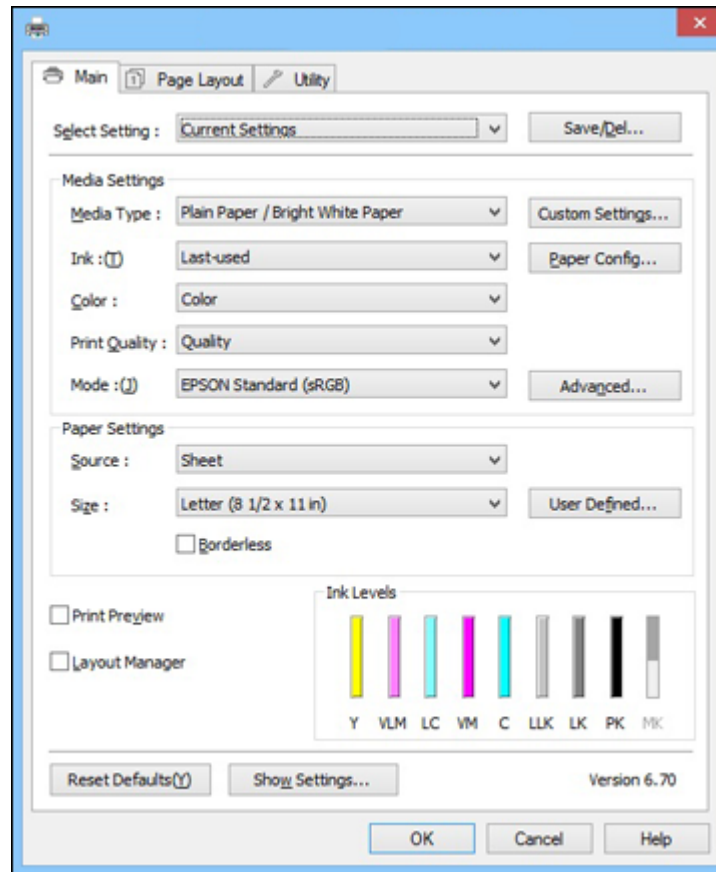

3. Select the print settings you want to use as defaults in all your Windows programs.

4. Click **OK**.

These settings are now the defaults selected for printing. You can still change them as needed for printing in any program session.

Parent topic: [Printing with Windows](#)

Changing the Language of the Printer Software Screens

You can change the language used on the Windows printer software screens.

1. Access the Windows Desktop and right-click the product icon in the Windows taskbar.
2. Select **Printer Settings**.

You see the printer settings window.

3. Click the **Utility** tab.

You see these options:

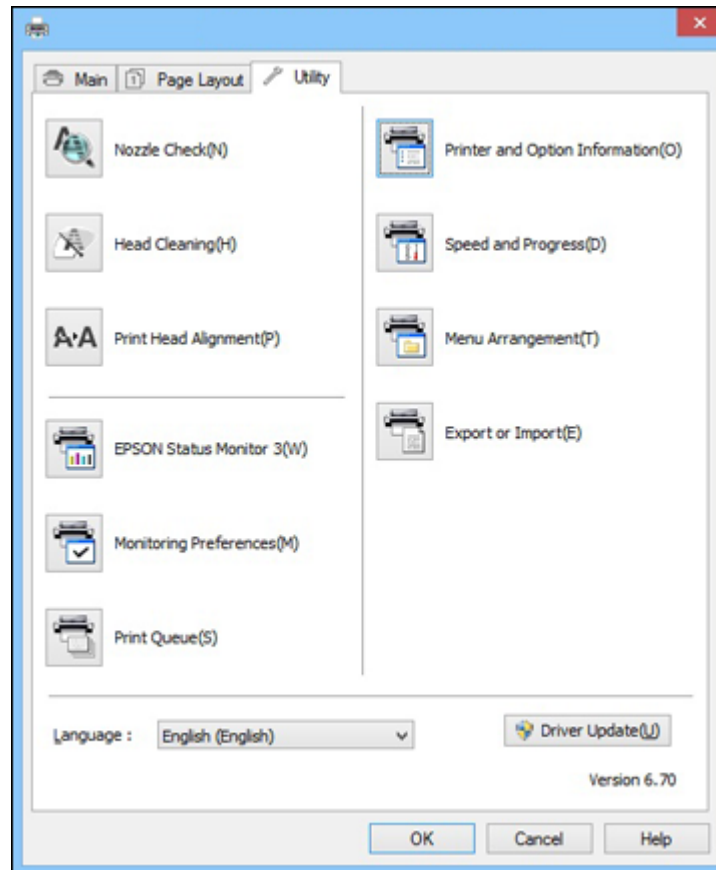

4. Select the language you want to use as the **Language** setting.
5. Click **OK** to close the printer software window.

The printer software screens appear in the language you selected the next time you access them.

Parent topic: [Printing with Windows](#)

Changing Automatic Update Options

Your printer software for Windows automatically checks for updates to the product software. You can change how often the software checks for updates or disable this feature.

1. Access the Windows Desktop and right-click the product icon in the Windows taskbar.
2. Select **Software Update Settings**.

You see this window:

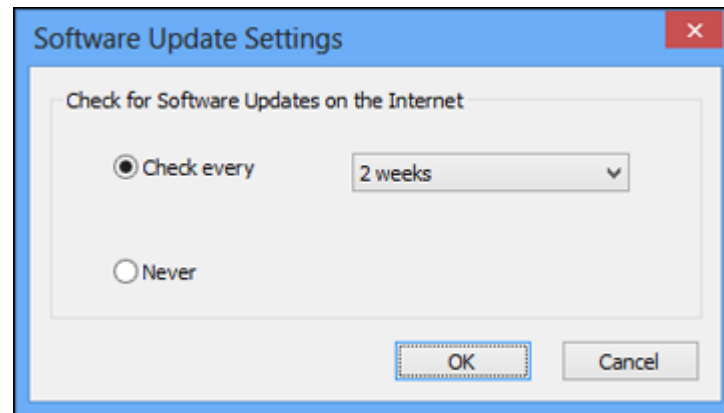

3. Do one of the following:
 - To change how often the software checks for updates, select a setting in the **Check every** menu.
 - To disable the automatic update feature, select the **Never** option.
4. Click **OK** to exit.

Note: If you choose to disable the automatic update feature, you can check for updates manually.

Parent topic: [Printing with Windows](#)

Related tasks

[Checking for Software Updates](#)

Printing with OS X

You can print with your product using any OS X printing program, as described in these sections.

Note: If you have an Internet connection, it is a good idea to check for updates to your product software on Epson's support website.

[Selecting Basic Print Settings - OS X](#)

[Selecting Roll Paper Settings - OS X](#)

[Selecting Paper Configuration Settings - OS X](#)

[Selecting Print Layout Options - OS X](#)

[Managing Color - OS X](#)

[Sizing Printed Images - OS X](#)

[Selecting Printing Preferences - OS X](#)

[Printing Your Document or Photo - OS X](#)

Parent topic: [Printing from a Computer](#)

Selecting Basic Print Settings - OS X

Select the basic settings for the photo or document you want to print.

1. Open a photo or document for printing.
2. Select the print command in your application.

Note: You may need to select a print icon on your screen, the **Print** option in the File menu, or another command. See your application's help utility for details.

3. Select your product as the **Printer** setting.

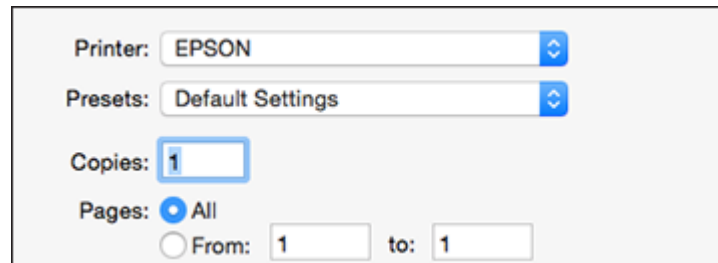

The image shows a printer settings dialog box with the following controls:

- Printer:** A dropdown menu with "EPSON" selected and a blue arrow icon on the right.
- Presets:** A dropdown menu with "Default Settings" selected and a blue arrow icon on the right.
- Copies:** A text input field containing the number "1", which is highlighted with a blue border.
- Pages:** A radio button labeled "All" is selected. Below it, an unselected radio button is followed by the text "From: 1" and "to: 1", each in its own text input field.

4. If necessary, click the arrow next to the Printer setting or the **Show Details** button to expand the print window.

You see the expanded printer settings window for your product:

The image shows a printer settings dialog box for an EPSON printer. The settings are as follows:

- Printer: EPSON
- Presets: Default Settings
- Copies: 1
- Pages: All, From: 1 to: 1
- Paper Size: US Letter (8.50 by 11.00 inches)
- Orientation: Portrait (selected), Landscape
- Preview: Preview
- Auto Rotate
- Scale: Scale: 100%, Scale to Fit: Print Entire Image, Fill Entire Paper
- Copies per page: 1

Buttons: Cancel, Print

Note: The print window may look different, depending on the version of OS X and the application you are using.

5. Select the **Copies** and **Pages** settings as necessary.

Note: If you do not see these settings in the print window, check for them in your application before printing.

6. Select the size of the paper you loaded as the **Paper Size** setting.
 - To print a borderless photo, select the **Borderless** checkbox or a paper size with a **Borderless** option. You can also create a custom paper size, but the highest available **Output Resolution** setting is limited to **Fine - 720 dpi**.
 - To print on roll paper, select a roll paper size or one with a **Borderless** option.

Note: For roll paper, make sure the maximum width of your photo is set to 13 inches to fit in the width of your roll paper (set the margins to 0 in your application software).

- To print on paper loaded in the manual feed tray, select a paper size with a **Front Fine Art** option.

Note: You can reduce or enlarge the size of the printed image by selecting **Paper Handling** from the pop-up menu and selecting a scaling option.

Note: If you do not see these settings in the print window, check for them in your application before printing. They may be accessible by selecting **Page Setup** from the File menu.

7. Choose portrait or landscape as the **Orientation** setting.
8. Select any application-specific settings that appear on the screen, such as those shown in the image above for the Preview application.
9. Select **Printer Settings** from the pop-up menu.

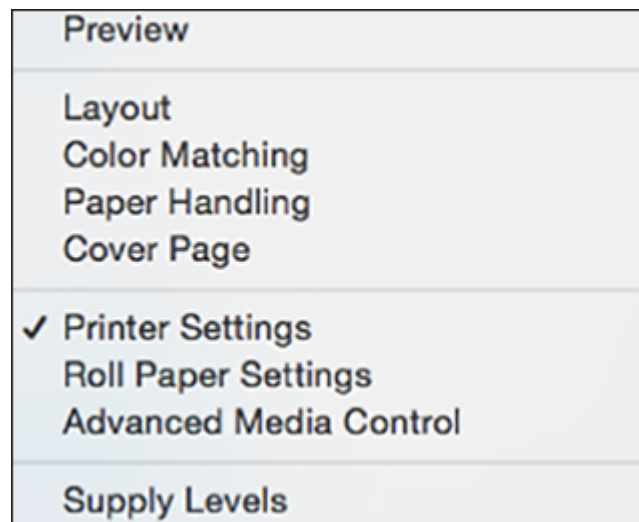

Note: In certain programs, you may need to select **Advanced** before you can select **Printer Settings**. For more information about printer settings, click the ? button.

You see these settings:

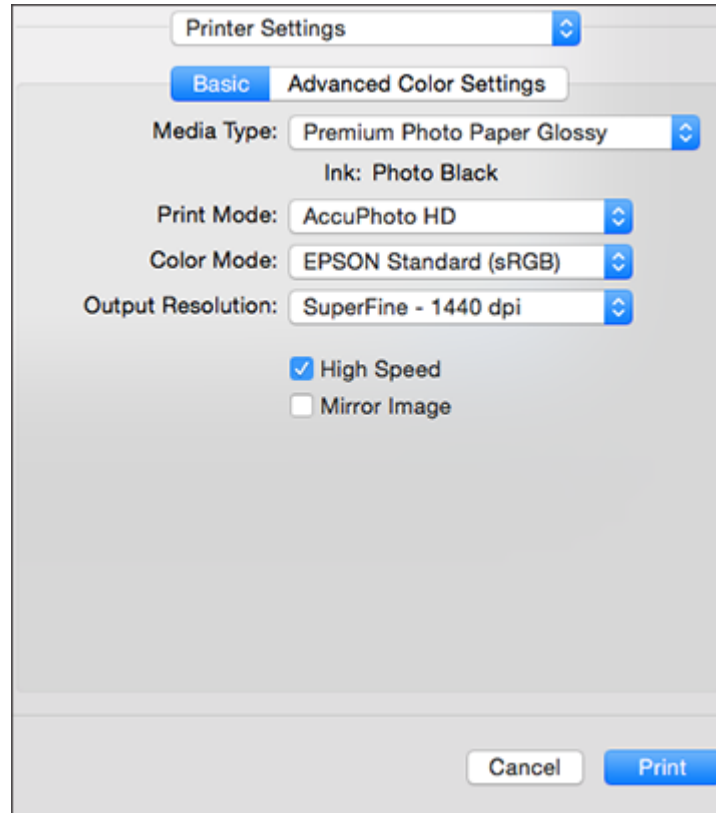

10. Select the type of paper you loaded as the **Media Type** setting.

Note: The setting may not exactly match the name of your paper. Check the media type settings list for details.

Note: The ink type may change depending on the size and type of paper you select. To avoid changing black ink more often than necessary, set the printer to the type of black ink you usually use.

11. Select one of the following as the **Print Mode** setting:
 - Select **AccuPhoto HD** for any type of photographic printing.
 - Select **Advanced B&W Photo** to print black-and-white photos on certain types of photo paper. See the list of Advanced B&W Photo options for details. If your paper type does not support this option, print black-and-white photos using the **AccuPhoto HD** setting.
 - Select **Black/Grayscale** when using plain paper.
12. Click **Color Mode** and select **Manual Settings**.
13. Select one of the following as the **Color Mode** setting:
 - **EPSON Standard (sRGB)**: Increases the contrast in images. Click the **Advanced Color Settings** tab to use advanced color controls.
 - **Adobe RGB**: Matches image colors to the Adobe RGB color standard. Use this setting if your source file was captured in Adobe RGB. Click the **Advanced Color Settings** tab to use advanced color controls.
 - **Off (No Color Adjustment)**: Turns off color management in your printer software so you can manage color using only your application software.

Note: If desired, you can instead use ColorSync to manage colors. In most cases, you get better results by applying color management in your application, rather than in the printer driver.

14. Select the **Output Resolution** setting you want to use.
15. Select any of the available print options.

[Advanced Color Settings - OS X](#)

[Output Resolution Settings - OS X](#)

[Print Options - OS X](#)

Parent topic: [Printing with OS X](#)

Related references

[Paper or Media Type Settings - Product Software](#)

Related tasks

[Printing Your Document or Photo - OS X](#)

[Selecting Roll Paper Settings - OS X](#)

Advanced Color Settings - OS X

When you click the **Advanced Color Settings** tab, you see one of the screens below depending on the **Print Mode** you selected.

- **AccuPhoto HD**

You can specify values for adjusting brightness, contrast, saturation, and individual Cyan, Magenta, and Yellow color tones.

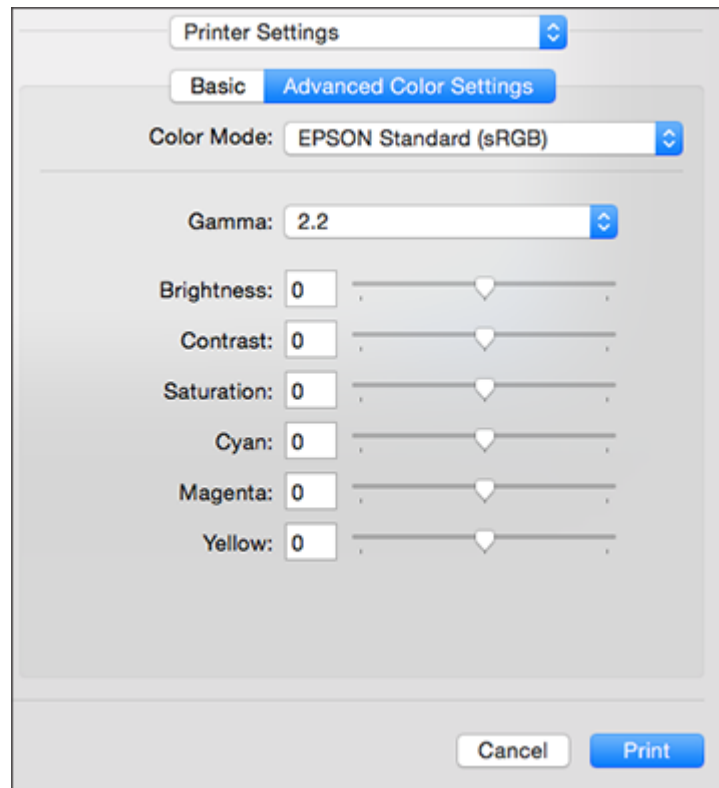

- **Advanced B&W Photo**

You can select any of the available options.

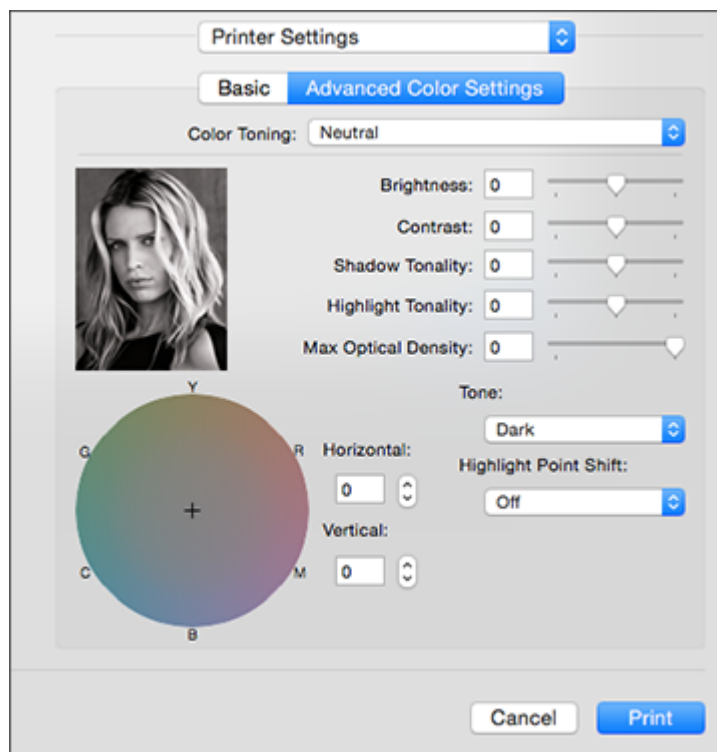

Color Toning

Adds tone (hue) to your black-and-white output. The default is **Neutral**, which provides a neutral tonal scale print. You can also choose other popular presets such as **Cool**, **Warm**, and **Sepia**. Note that the presets affect the target found in the tone color circle.

Brightness

Adjusts the overall lightness and darkness of your image.

Contrast

Adjusts the difference between the light and dark areas of the overall image.

Shadow Tonality

Controls tonality only in the shadow areas of your image.

Highlight Tonality

Controls tonality only in the highlight areas of your image.

Max Optical Density

Adjusts the overall density or focus of the print. Create a soft focus print by lowering the density setting.

Tone

Changes the entire tonal scale of your black-and-white output. While **Darker** is the default setting, you may see better results if you choose **Dark**. The tone color circle adjusts the hue of your black-and-white print. Click on any portion of the color wheel or enter corresponding values to customize the tone (hue) to add to your print. The closer you select to the edge of the wheel, the more color you add.

Highlight Point Shift

Helps reduce gloss differential on glossy media by adding density to the highlights of your image.

Parent topic: [Selecting Basic Print Settings - OS X](#)

Output Resolution Settings - OS X

You can select any of the **Output Resolution** settings to fine-tune the quality of your print. Some settings may be unavailable, depending on the paper type and border setting you have chosen.

Draft

For draft printing on photo paper.

Fine - 720 dpi

For everyday text and image printing.

Super Fine - 1440 dpi

For photos and graphics with good print quality and speed.

Photo - 1440 dpi

For photos and graphics with high print quality and slower speed.

SuperPhoto - 5760 dpi

For the best print quality but the slowest print speed.

Parent topic: [Selecting Basic Print Settings - OS X](#)

Print Options - OS X

You can select any of the print options to customize your print. Some options may be unavailable, depending on other settings you have chosen.

High Speed

Speeds up printing but may reduce print quality.

Mirror Image

Flips the printed image left to right.

Parent topic: [Selecting Basic Print Settings - OS X](#)

Selecting Roll Paper Settings - OS X

To print on roll paper, you select the roll paper size and roll paper options from the Printer Settings menu.

1. Select **Manage Custom Sizes** as the **Paper Size** setting.
2. Click **+**, double-click **Untitled**, and enter a name for your roll paper size.
3. Enter one of the following as the **Width** setting:
 - **8.3** for 8.3-inch (211 mm) wide roll paper
 - **12.95** for 13-inch (330 mm) wide roll paper

Note: Make sure your image fits within the width of your roll paper.

4. Enter the length of your roll paper image as the **Height** setting (up to 44 inches [1118 mm]).
5. Set the margin setting to **0**.
6. Click **OK**.
7. Select your new custom roll paper size as the **Paper Size** setting.
8. Select **Roll Paper Settings**.

You see this window:

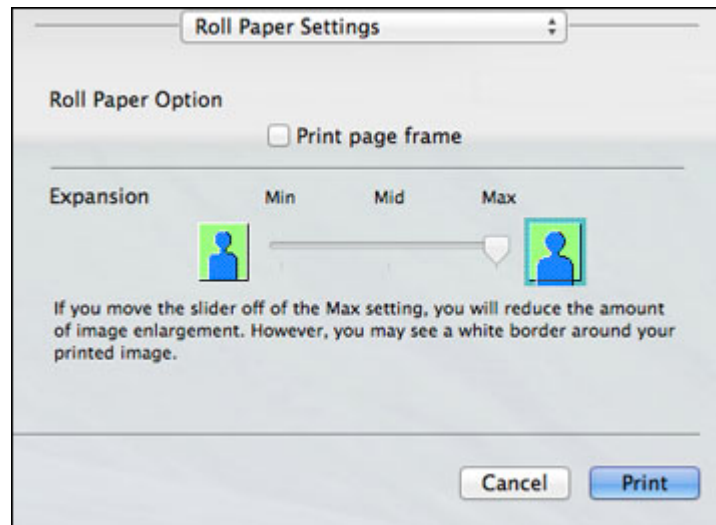

Note: Some settings may not be available, depending on the Roll Paper option you selected for your Paper Size.

9. Select the following settings as necessary:
 - Click **Print page frame** to print a cutting guideline around images.
 - Adjust the amount of image expansion when printing borderless images.

Note: This option is available only when you choose a Paper Size setting with a **Borderless** option.

10. Click **Print**.

Parent topic: [Printing with OS X](#)

Selecting Paper Configuration Settings - OS X

If you are using non-Epson media and need to fine-tune its print quality, select **Advanced Media Control** from the pop-up menu. Select the available options as necessary.

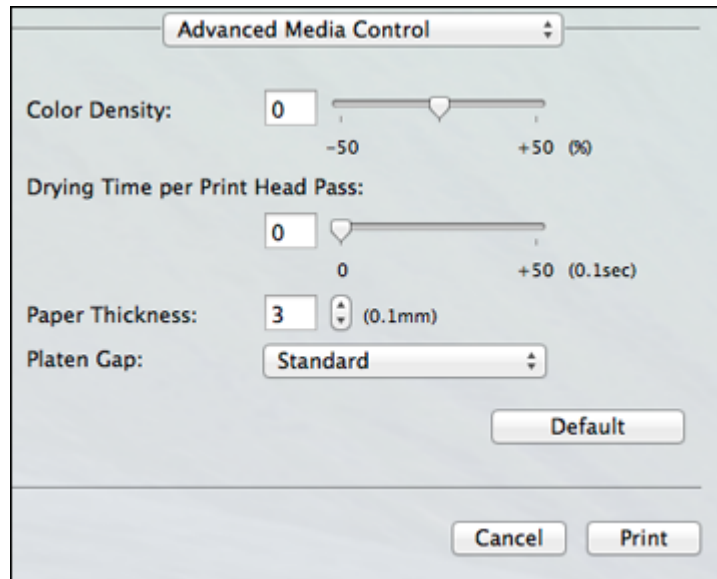

[Advanced Media Control Options - OS X](#)

Parent topic: [Printing with OS X](#)

Advanced Media Control Options - OS X

Select any of the available Advanced Media Control options to fine-tune the quality of your printouts.

Color Density

Adjusts the ink saturation level.

Drying Time per Print Head Pass

Pauses print head movement for up to 5 seconds after each pass to allow ink to dry. This lets you print with non-Epson media and avoid smearing the ink.

Paper Thickness

Lets you select the thickness of your paper or media.

Platen Gap

Adjusts the distance from the paper to the print head. (Use a wider setting if you are seeing edge marks or scuffs on your prints.)

Parent topic: [Selecting Paper Configuration Settings - OS X](#)

Selecting Print Layout Options - OS X

You can select a variety of layout options by selecting **Layout** from the pop-up menu on the print window.

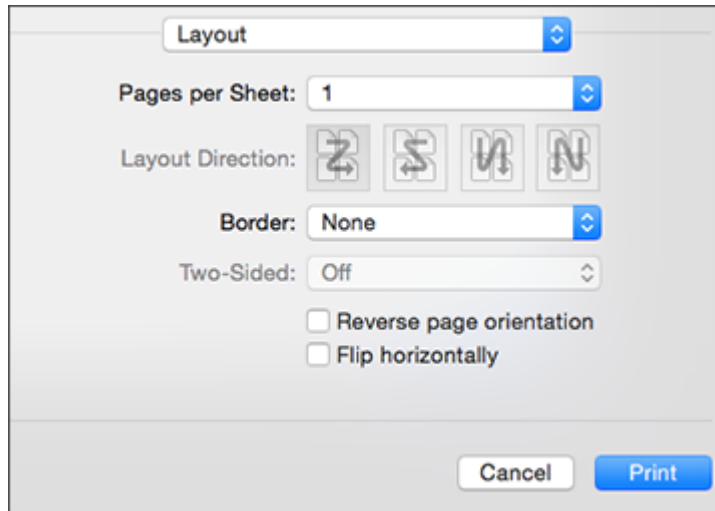

- To print multiple pages on one sheet of paper, select the number of pages in the **Pages per Sheet** pop-up menu. To arrange the print order of the pages, select a **Layout Direction** setting.
- To print borders around each page on the sheet, select a line setting from the **Border** pop-up menu.
- To invert or flip the printed image, select the **Reverse page orientation** or **Flip horizontally** settings.

Parent topic: [Printing with OS X](#)

Managing Color - OS X

You can adjust the Color Matching settings to fine-tune the colors in your printout, or turn off color management in your printer software.

1. Select **Color Matching** from the pop-up menu in the print window.

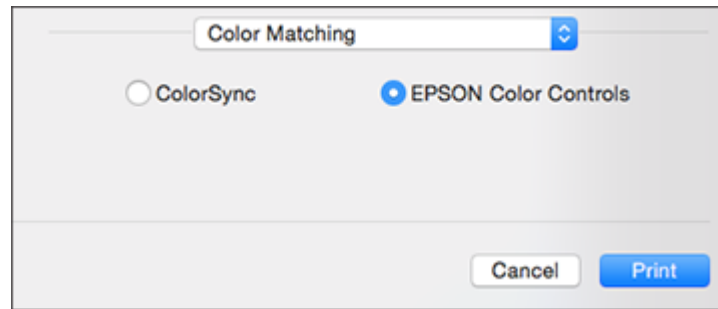

2. Select one of the available options.

[Color Matching Options - OS X](#)

Parent topic: [Printing with OS X](#)

Color Matching Options - OS X

You can select from these settings on the **Color Matching** menu.

ColorSync

Prints using standard color profiles for your product and paper to help match image colors. You can customize the conversion method and filter settings on the ColorSync pop-up menu in the print window.

EPSON Color Controls

Lets you manage color using controls in your printer software or turn off color management.

Parent topic: [Managing Color - OS X](#)

Related tasks

[Selecting Basic Print Settings - OS X](#)

Sizing Printed Images - OS X

You can adjust the size of the image as you print it by selecting **Paper Handling** from the pop-up menu on the Print window.

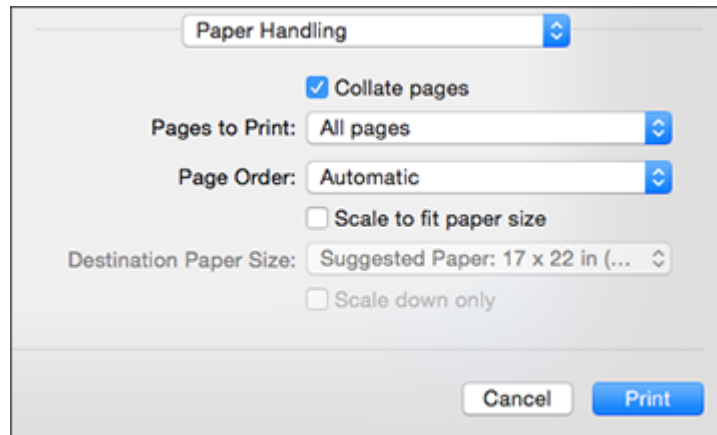

- To collate multiple copies into sets of documents, select the **Collate pages** checkbox.
- To print only selected pages in a multi-page document, select an option from the **Pages to Print** pop-up menu.
- To adjust the order in which pages are printed, select an option from the **Page Order** pop-up menu.
- To scale the image to fit on a specific paper size, select the **Scale to fit paper size** checkbox and select a paper size from the **Destination Paper Size** pop-up menu.
- To restrict scaling of the image to reduced sizing, select the **Scale down only** checkbox. (Deselect this checkbox when enlarging the image.)

Parent topic: [Printing with OS X](#)

Selecting Printing Preferences - OS X

You can select printing preferences that apply to all the print jobs you send to your product.

1. In the Apple menu or the Dock, select **System Preferences**.
2. Select **Print & Fax**, **Print & Scan**, or **Printers & Scanners**, select your product, and select **Options & Supplies**.
3. Select **Options**.

You see a screen like this:

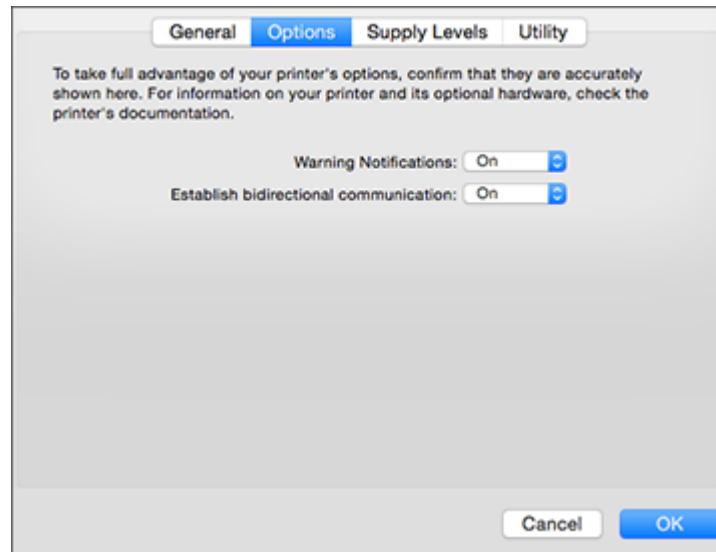

4. Select any of the available printing options.
5. Click **OK**.

[Printing Preferences - OS X](#)

Parent topic: [Printing with OS X](#)

Printing Preferences - OS X

You can select from these settings on the **Options** tab.

Warning Notifications

Lets you choose whether or not to receive warning notifications from the printer software for various operating conditions.

Establish bidirectional communication

Allows the product to communicate with the computer. Do not change the default setting unless you experience issues when using a shared printing pool.

Parent topic: [Selecting Printing Preferences - OS X](#)

Printing Your Document or Photo - OS X

Once you have selected your print settings, you are ready to print.
Click **Print** at the bottom of the print window.

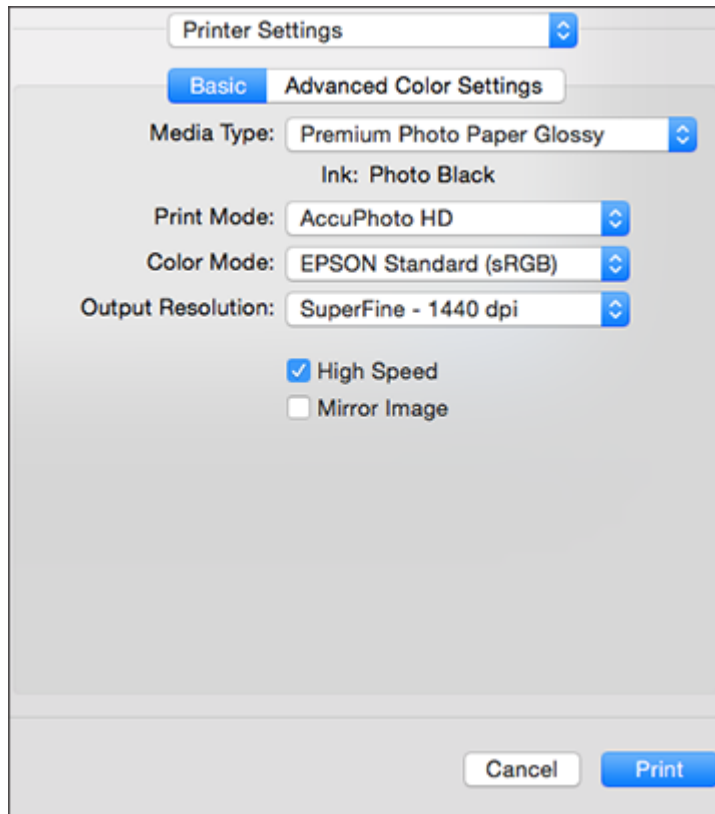

[Checking Print Status - OS X](#)

Parent topic: [Printing with OS X](#)

Checking Print Status - OS X

During printing, you can view the progress of your print job, control printing, and check ink status.

1. Click the printer icon when it appears in the Dock.

You see the print status window:

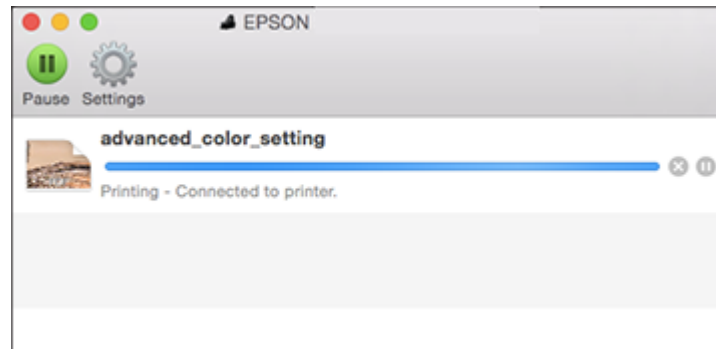



2. Select the following options as necessary:

OS X 10.7:

- To cancel printing, click the print job and click the **Delete** icon.
- To pause a print job, click the print job and click the **Hold** icon. To resume a print job, click the print job marked "Hold" and click the **Resume** icon.
- To pause printing for all queued print jobs, click the **Pause Printer** icon.
- To check ink status, click the **Supply Levels** icon.

OS X 10.8/10.9/10.10:

- To cancel printing, click the  button next to the print job.
- To pause a print job, click the  button next to the print job. To resume a print job, click the  button.
- To pause printing for all queued print jobs, click the large **Pause** button.
- To check ink status, click the **Settings** icon, then click the **Supply Levels** tab.

Parent topic: [Printing Your Document or Photo - OS X](#)

Printing on CDs/DVDs

Follow the instructions here to print a design onto ink jet-printable CDs or DVDs to create a custom label.

[Loading a CD/DVD](#)

[Removing a Printed CD/DVD](#)

[Printing on CDs/DVDs from a Computer](#)

Loading a CD/DVD

You can use your printer and the Epson Print CD software that came with it to print label designs directly onto ink jet-printable CDs or DVDs. To prevent errors, you should burn files, music, or video onto your CD or DVD before printing.

1. Turn on the printer.
2. Remove any roll paper or paper loaded in the sheet feeder. Close the rear support if it's open.

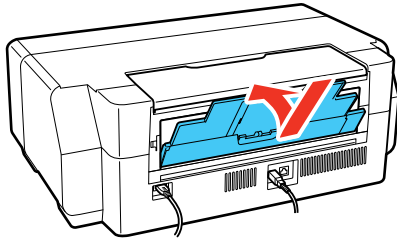

3. Open the front cover.

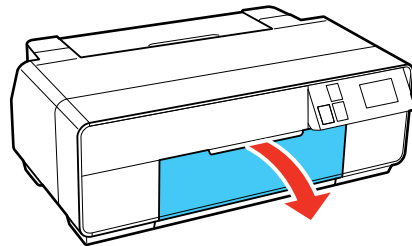

4. Push the center of the manual feed tray to extend it.

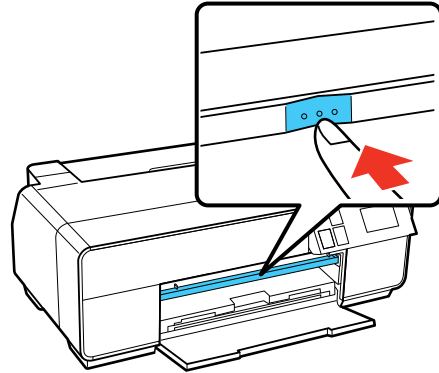

5. Place your disc on the included CD/DVD tray with the label side up.

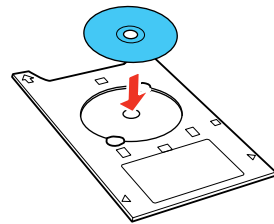

6. Place the CD/DVD tray on the front manual feed tray.

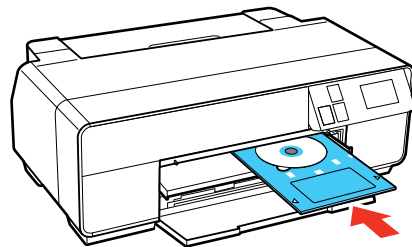

7. Line up the arrows on the CD/DVD tray with the line on the manual feed tray. Make sure the CD/DVD tray is flush against the right.

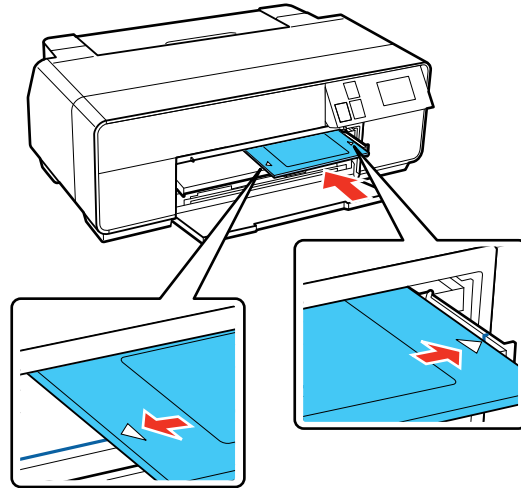

8. Press **CD/DVD - Load** on the touch screen. The CD/DVD tray loads inside the printer.

Parent topic: [Printing on CDs/DVDs](#)

Removing a Printed CD/DVD

After your CD or DVD is printed, the tray ejects partially from the printer. Pull out the tray and remove the disc.

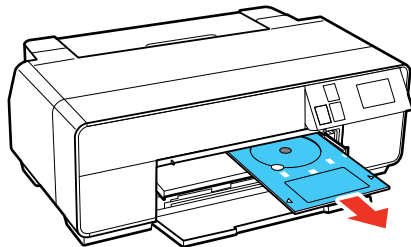

Note: If you want to remove the CD/DVD tray without printing, press **Eject** on the touch screen and follow the on-screen instructions.

Parent topic: [Printing on CDs/DVDs](#)

Printing on CDs/DVDs from a Computer

Before printing directly on CDs or DVDs from your computer, make sure you have set up your product as described on the *Start Here* sheet, and installed the Epson Print CD software.

[Starting Epson Print CD - Windows](#)

[Printing Your CD/DVD Design - Windows](#)

[Starting Epson Print CD - OS X](#)

[Printing Your CD/DVD Design - OS X](#)

Parent topic: [Printing on CDs/DVDs](#)

Starting Epson Print CD - Windows

You can use Epson Print CD to design your disc by importing photos, adding text, and creating special effects.

1. Select the Epson Print CD icon on your Windows Desktop.

You see a screen like this:

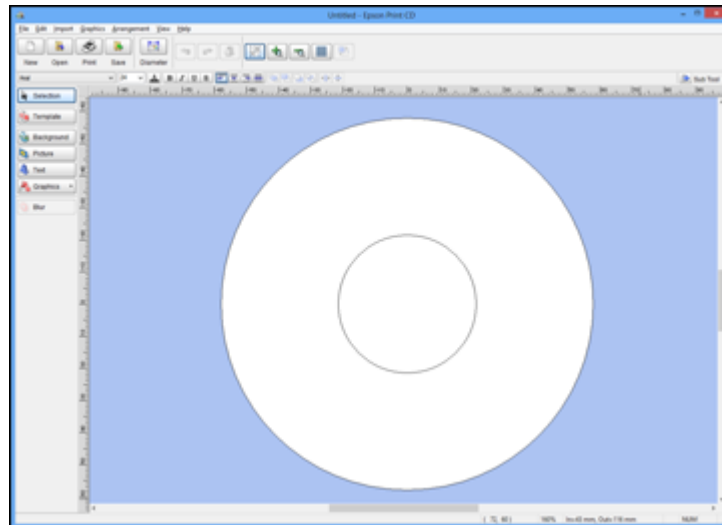

2. Use the buttons on the left side of the screen to select a pre-designed template or add a background image, picture, text, or graphic elements. For more information, select the **Help** menu.
3. When you are finished creating your design, click **Save** and save your design file.

Parent topic: [Printing on CDs/DVDs from a Computer](#)

Printing Your CD/DVD Design - Windows

After you create your design, you can print it on paper to test it, then print it on the CD or DVD that contains your data, photos, video, or music. Make sure the disc is loaded for printing before you start.

1. Open your file in Epson Print CD and click **Print**.

You see a screen like this:

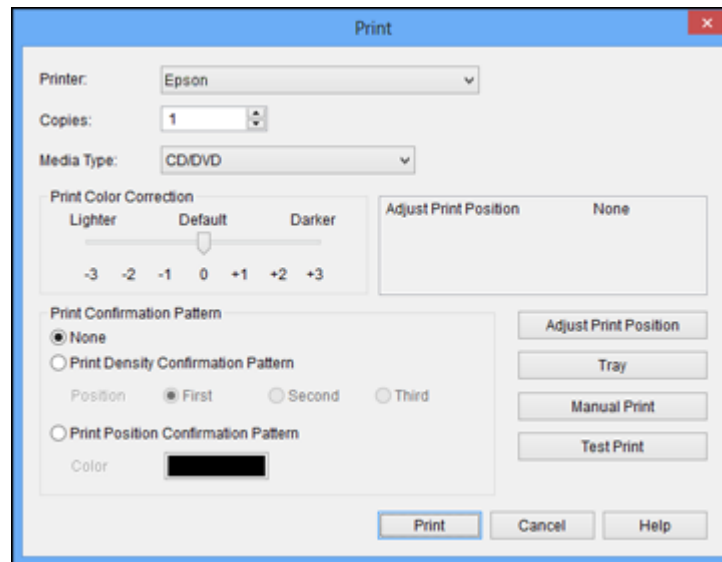

2. Make sure your product is selected as the **Printer** setting.
3. To see how your design will look without printing on the disc, click **Test Print** and follow the instructions on the screen.
4. When you are ready to print on the disc, click the **Print** button on the screen.
5. Click **Print**.

Note: If you need to adjust the print position or print quality, see the Epson Print CD Help utility for instructions.

Parent topic: [Printing on CDs/DVDs from a Computer](#)

Starting Epson Print CD - OS X

You can use Epson Print CD to design your disc by importing photos, adding text, and creating special effects.

1. Open the Epson Print CD program in the **Applications > Epson Software > Print CD** folder on your Mac.

You see a screen like this:

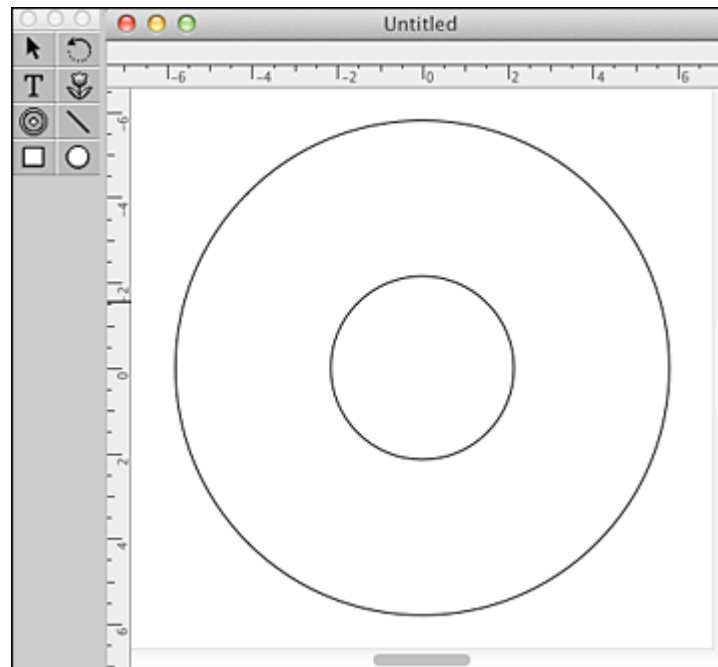

2. Use the icons on the left side of the screen to add a background image, picture, text, or graphic elements.
3. When you are finished creating your design, make sure you save it.

Parent topic: [Printing on CDs/DVDs from a Computer](#)

Printing Your CD/DVD Design - OS X

After you create your design, you can print it on paper to test it, then print it on the CD or DVD that contains your data, photos, video, or music. Make sure the disc is loaded for printing before you start.

1. Open your file in Epson Print CD and select **Print** from the File menu.

You see a screen like this:

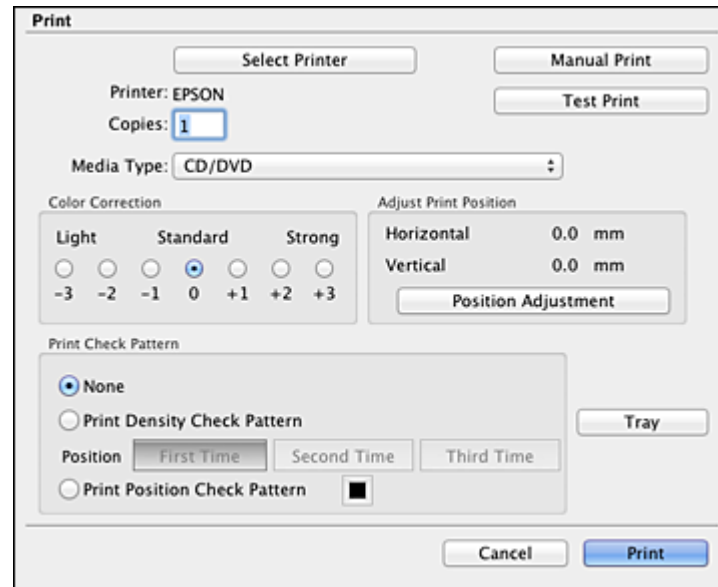

2. Make sure your product is selected as the **Printer** setting.
3. To see how your design will look without printing on the disc, select **Test Print** and follow the instructions on the screen.
4. When you are ready to print on the disc, click the **Print** button on the screen.

Note: If you need to adjust the print position or print quality, see the Epson Print CD Help utility for instructions.

Parent topic: [Printing on CDs/DVDs from a Computer](#)

Replacing Ink Cartridges

When an ink cartridge is expended, you need to replace it.

You may also need to replace a cartridge that is more than six months old, or if your printouts do not look their best, even after cleaning and aligning the print head.

Note: Please dispose of your used Epson branded ink cartridges responsibly and in accordance with local requirements. If you would like to return your used ink cartridges to Epson for proper disposal, please go to epson.com/recycle for more information.

[Check Cartridge Status](#)

[Purchase Epson Ink Cartridges](#)

[Removing and Installing Ink Cartridges](#)

[Switch Black Ink Type](#)

Check Cartridge Status

Your product and its printing software will let you know when an ink cartridge is low or expended.

[Checking Cartridge Status on the LCD Screen](#)



[Checking Cartridge Status with Windows](#)

[Checking Cartridge Status with OS X](#)

Parent topic: [Replacing Ink Cartridges](#)

Checking Cartridge Status on the LCD Screen

When one of your cartridges is low or expended, your product's LCD screen displays an error message. You can also check the cartridge status at any time, as described here.

1. Press the  home button.
2. Press the  remaining ink display button.
You see the Ink Levels screen.
3. For more information, select **Cartridge Information** at the bottom of the screen.

Note: The displayed ink levels are approximate.

Parent topic: [Check Cartridge Status](#)

Related tasks

[Removing and Installing Ink Cartridges](#)

Checking Cartridge Status with Windows

A low ink reminder appears if you try to print when ink is low, and you can check your cartridge status at any time using a utility on your Windows computer.

1. To check your cartridge status, access the Windows Desktop and double-click the product icon in the Windows taskbar.

You see this window:

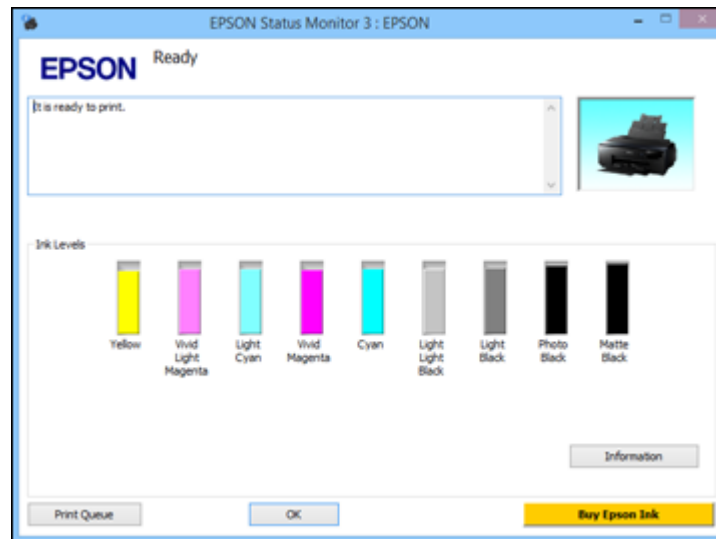

2. Replace or reinstall any ink cartridge indicated on the screen.

Note: If any of the cartridges installed in the product are broken, incompatible with the product model, or improperly installed, Epson Status Monitor will not display an accurate cartridge status.

3. To disable the low ink reminder, right-click the product icon in the Windows taskbar and select **Monitoring Preferences**.

You see this window:

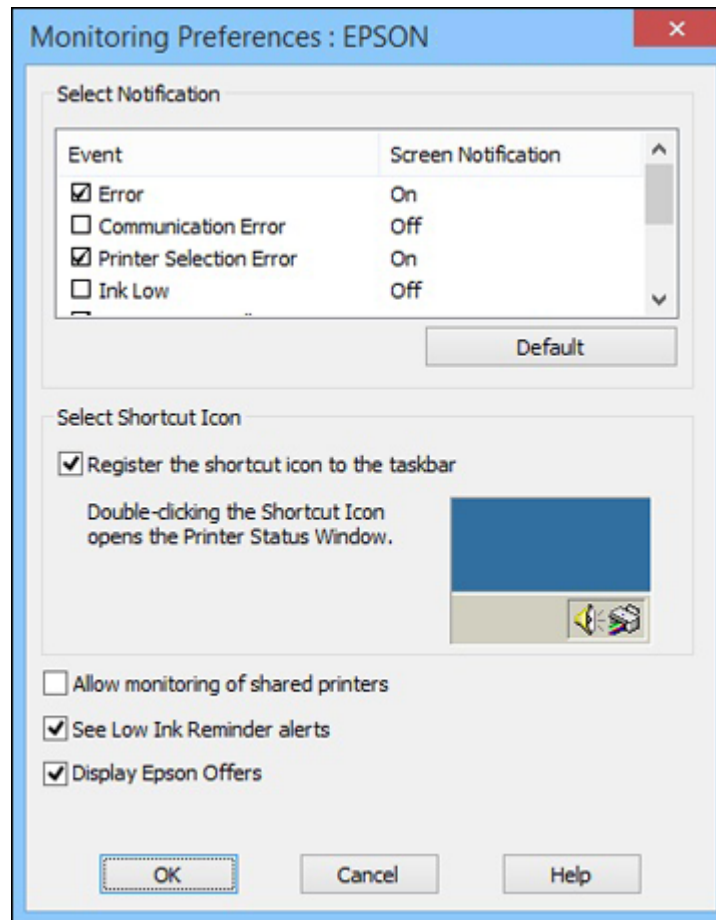

4. Deselect the **See Low Ink Reminder alerts** checkbox at the bottom of the screen.
5. To disable promotional offers, deselect the **Display Epson Offers** checkbox.

Parent topic: [Check Cartridge Status](#)

Related tasks

[Removing and Installing Ink Cartridges](#)

[Checking Cartridge Status on the LCD Screen](#)

Checking Cartridge Status with OS X

You can check your cartridge status using a utility on your Mac.

1. In the Apple menu or the Dock, select **System Preferences**. Select **Print & Fax**, **Print & Scan**, or **Printers & Scanners**, select your product, and select **Options & Supplies**. Select **Utility** and select **Open Printer Utility**.
2. Select **EPSON Status Monitor**.

You see a window like this:

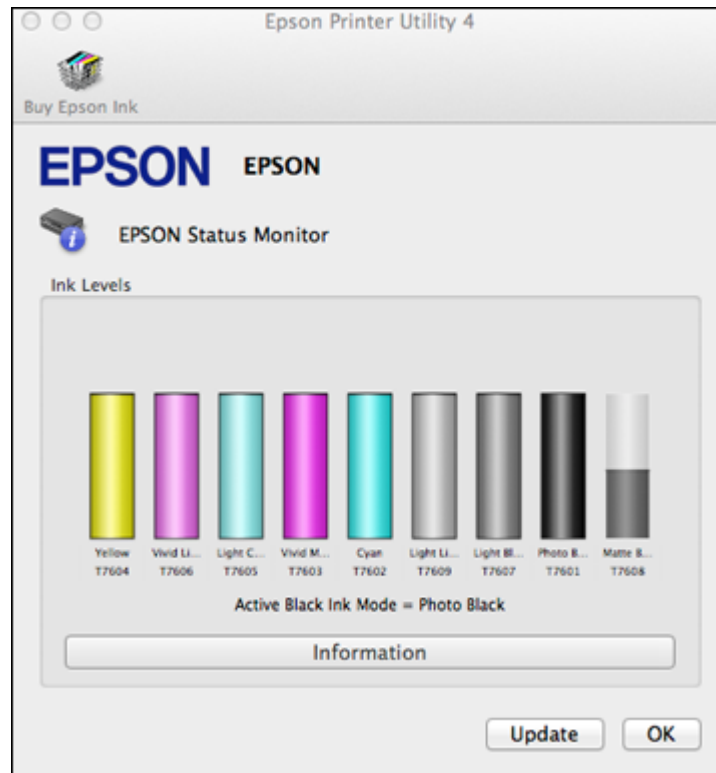

3. Do the following as necessary:
 - To update the ink cartridge status, click **Update**.

- Replace or reinstall any ink cartridge indicated on the screen.

Note: If any of the cartridges installed in the product is broken, incompatible with the product model, or improperly installed, Epson Status Monitor will not display an accurate cartridge status.

Parent topic: [Check Cartridge Status](#)

Related tasks

[Removing and Installing Ink Cartridges](#)

[Checking Cartridge Status on the LCD Screen](#)

Purchase Epson Ink Cartridges

You can purchase genuine Epson ink and paper at epson.com/ink3 (U.S. sales) or epson.ca (Canadian sales). You can also purchase supplies from an Epson authorized reseller. To find the nearest one, call 800-GO-EPSON (800-463-7766).

Note: We recommend that you use genuine Epson cartridges and do not refill them. The use of other products may affect your print quality and could result in printer damage.

The cartridges included with the printer are designed for printer setup and not for resale. After some ink is used for charging, the rest is available for printing. Yields vary considerably based on images printed, print settings, paper type, frequency of use, and temperature. For print quality, a variable amount of ink remains in the cartridge after the "replace cartridge" indicator comes on.

[Ink Cartridge Part Numbers](#)

Parent topic: [Replacing Ink Cartridges](#)

Ink Cartridge Part Numbers

Use these part numbers when you order or purchase new ink cartridges.

Note: For best printing results, use up a cartridge within 6 months of opening the package.

Ink color	Part number
Photo Black	760
Cyan	760
Vivid Magenta	760

Ink color	Part number
Yellow	760
Light Cyan	760
Vivid Light Magenta	760
Light Black	760
Matte Black	760
Light Light Black	760

Parent topic: [Purchase Epson Ink Cartridges](#)

Removing and Installing Ink Cartridges

Make sure you have your replacement cartridges handy before you begin. You must install new cartridges immediately after removing the old ones.

Caution: Leave your old cartridges in the printer until you are ready to replace them to prevent the print head nozzles from drying out. Do not open ink cartridge packages until you are ready to install the ink. Cartridges are vacuum packed to maintain reliability.

1. Turn on your product.
2. Lift up the printer cover.

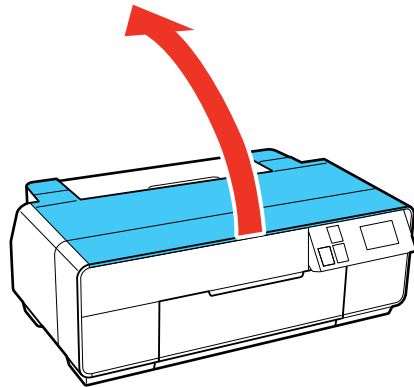

3. Press the latch and open the ink cartridge cover as shown.

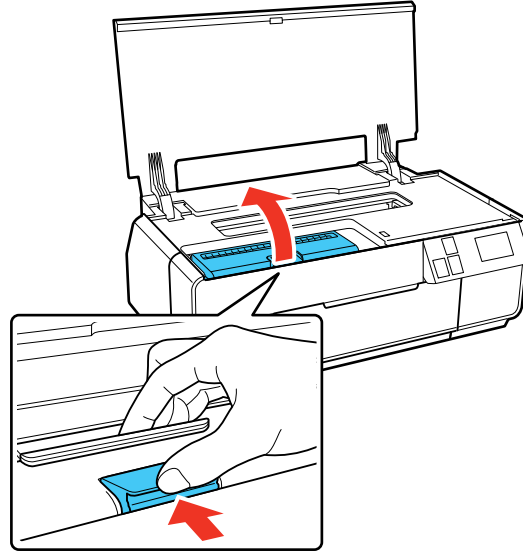

4. Squeeze the tab on the cartridge and lift the cartridge straight up to remove it.

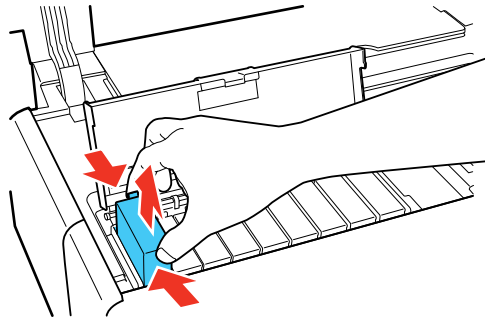

Note: Dispose of used cartridges carefully. Do not take the used cartridge apart or try to refill it.

Warning: If ink gets on your skin, wash it thoroughly with soap and water. If ink gets into your eyes, flush them immediately with water. If ink gets into your mouth, spit it out and see a doctor right away. Keep ink cartridges out of the reach of children.

5. Gently shake the new cartridge four or five times as shown. Then remove the cartridge from the package and remove the yellow tape from the bottom of the cartridge.

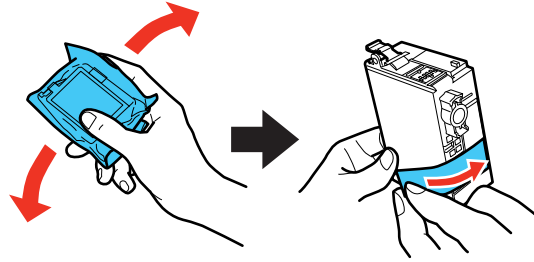

Caution: Cartridges may make a clicking sound when you shake them. Do not remove any labels or seals, or ink will leak. Do not touch the green chip on the cartridge.

6. Insert the new cartridge into the holder and push it down until it clicks into place.

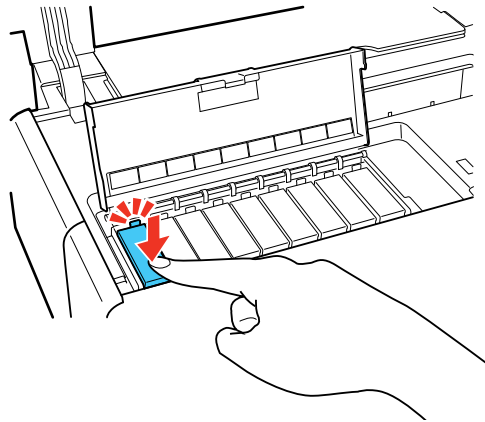

7. Close the cartridge cover and push it down until it clicks into place.

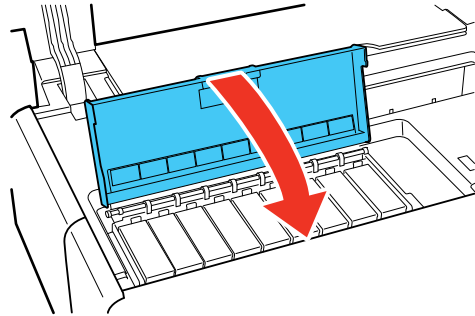

8. Close the printer cover.

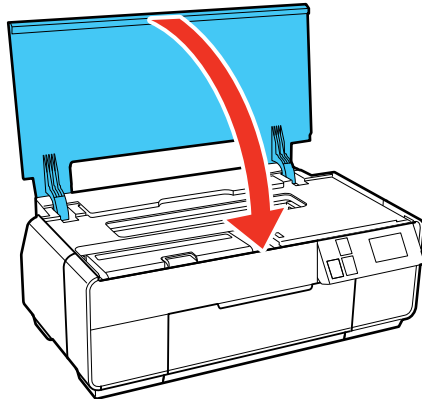

Note: Wait for your product to check the ink cartridges and charge the ink delivery system, if necessary. Do not turn off the product during ink charging.

Caution: If you remove an ink cartridge for later use, protect the ink supply area from dirt and dust and store it in the same environment as the printer. The valve in the ink supply port is designed to contain any excess ink, but do not touch the ink supply port or surrounding area. Always store ink cartridges with the label facing up; do not store cartridges upside-down.

Parent topic: [Replacing Ink Cartridges](#)

Switch Black Ink Type

Your product comes with Matte Black and Photo Black ink cartridges. Although both cartridges must be installed for your product to work, it can print using only one type of black ink at a time.

Your product switches the black ink type automatically, depending on the type of media you load. Because this process consumes some ink, so you should avoid switching black ink more often than necessary and select a default black ink type for the type of media you print on most often.

Note: To disable automatic black ink switching, press the  setup button and select **System Administration > Printer Settings > BK Ink Auto Change > Off**.

[Black Ink Type Media List](#)

[Switching the Black Ink Type](#)

Parent topic: [Replacing Ink Cartridges](#)

Black Ink Type Media List

To conserve ink, select the default black ink type that matches the type of media you usually print on.

Matte Black Ink Media Types

- Epson Presentation Paper Matte
- Epson Premium Presentation Paper Matte
- Epson Premium Presentation Paper Matte Double-sided
- Epson Ultra Premium Presentation Paper Matte
- Epson Velvet Fine Art Paper
- Epson Exhibition Watercolor Paper Textured
- Epson Watercolor Paper Radiant White
- Epson UltraSmooth Fine Art Paper 325 gsm
- Epson Exhibition Canvas Matte
- Epson Exhibition Canvas Natural Matte
- Epson Photo Quality Self-adhesive Sheets
- Epson Hot Press Bright
- Epson Hot Press Natural

- Epson Cold Press Bright
- Epson Cold Press Natural



Photo Black Ink Media Types

- Epson Photo Paper Glossy
- Epson Premium Photo Paper Glossy
- Epson Ultra Premium Photo Paper Glossy
- Epson Premium Photo Paper Semi-gloss
- Epson Ultra Premium Photo Paper Luster
- Epson Exhibition Canvas Gloss
- Epson Exhibition Canvas Satin
- Epson Exhibition Canvas Natural Satin
- Epson Exhibition Canvas Natural Gloss
- Epson Exhibition Fiber Paper
- Epson Metallic Photo Paper Glossy
- Epson Metallic Photo Paper Luster

Parent topic: [Switch Black Ink Type](#)

Switching the Black Ink Type

Switching the black ink type takes several minutes and consumes some ink. Check the black ink type media list to select the correct ink type for the media you loaded.

1. Press the  home button.
2. Press the  black ink change button.
3. Select **Proceed** and select one of these types of black ink to switch to:
 - Photo Black to Matte Black; switching takes about 1.5 minutes
 - Matte Black to Photo Black; switching takes about 3.5 minutes

Parent topic: [Switch Black Ink Type](#)

Related references

[Black Ink Type Media List](#)

Adjusting Print Quality

If your print quality declines, you may need to run a utility to clean or align the print head.

If running these utilities does not solve the problem, you may need to replace the ink cartridges.

[Print Head Maintenance](#)

[Print Head Alignment](#)

[Cleaning the Paper Guide](#)

Print Head Maintenance

If your printouts become too light, or you see dark or light bands across them, you may need to clean the print head nozzles. Cleaning uses ink, so clean the nozzles only if print quality declines.

You can check for clogged nozzles before you clean them so you don't clean them unnecessarily.

Note: You cannot clean the print head if an ink cartridge is expended, and may not be able to clean it when a cartridge is low. You must replace the cartridge first.

[Print Head Nozzle Check](#)

[Print Head Cleaning](#)

Parent topic: [Adjusting Print Quality](#)

Related tasks

[Removing and Installing Ink Cartridges](#)

Print Head Nozzle Check

You can print a nozzle check pattern to check for clogged nozzles.



[Checking the Nozzles Using the Product Control Panel](#)

[Checking the Nozzles Using a Computer Utility](#)

Parent topic: [Print Head Maintenance](#)

Checking the Nozzles Using the Product Control Panel

You can check the print head nozzles using the control panel on your product.

1. Press the  home button, if necessary.
2. Press the  setup button.

You see this screen:

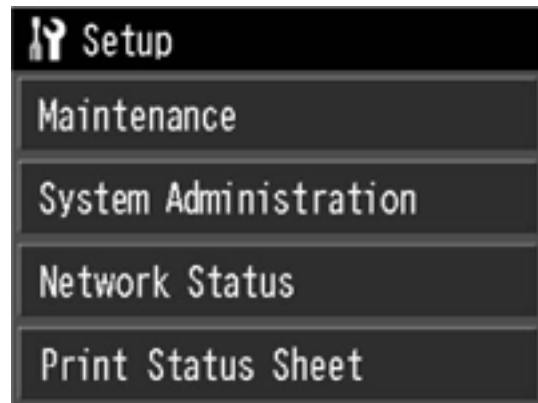

3. Select **Maintenance**.
4. Select **Print Head Nozzle Check**.
5. Load a few sheets of plain paper in the sheet feeder.
6. Select **Print**.
The nozzle pattern prints.
7. Check the printed pattern to see if there are gaps in the lines.

Print head is clean

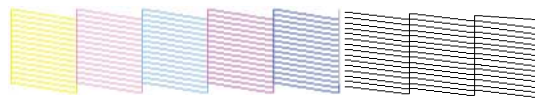

Print head needs cleaning

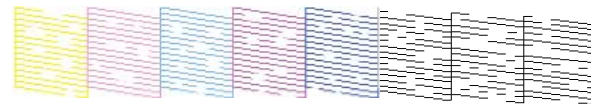

8. Do one of the following:
 - If there are no gaps, select **Done**.
 - If there are gaps or the pattern is faint, select **Clean the Print Head** and continue.
9. Follow the instructions on the screen to clean the print head, check the nozzles, and repeat the process as necessary.

If you don't see any improvement after cleaning the print head up to 4 times, wait at least 6 hours. Then try cleaning the print head again. If quality still does not improve, one of the ink cartridges may be old or damaged and needs to be replaced.

Parent topic: [Print Head Nozzle Check](#)

Related tasks

[Cleaning the Print Head Using the Product Control Panel](#)

[Removing and Installing Ink Cartridges](#)

Checking the Nozzles Using a Computer Utility

You can check the print head nozzles using a utility on your Windows or Mac computer.

1. Load a few sheets of plain paper in the sheet feeder.
2. Do one of the following:
 - **Windows:** Access the Windows Desktop and right-click the product icon in the Windows taskbar.
 - **OS X:** In the Apple menu or the Dock, select **System Preferences**. Select **Print & Fax**, **Print & Scan**, or **Printers & Scanners**, select your product, and select **Options & Supplies**. Select **Utility** and select **Open Printer Utility**.
3. Select **Nozzle Check**.

You see a window like this:

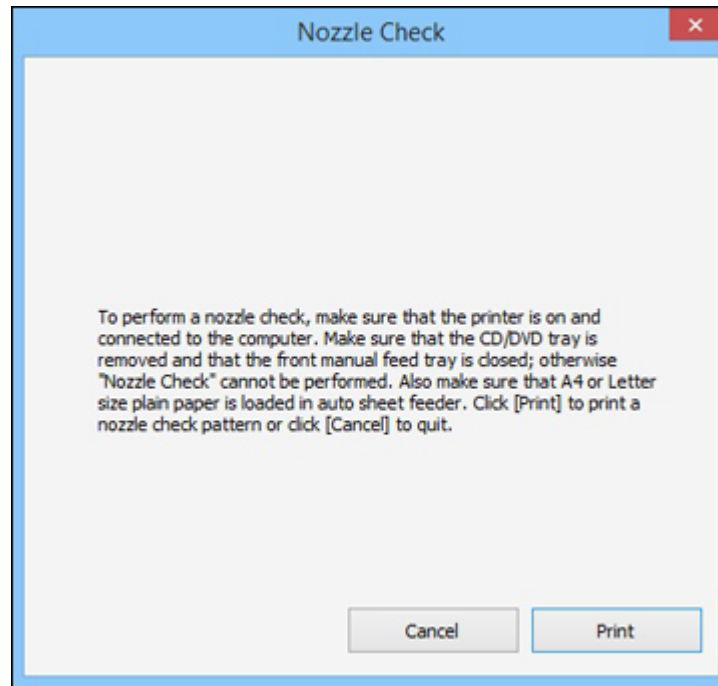

4. Click **Print**.
5. Check the printed pattern to see if there are gaps in the lines.

Print head is clean

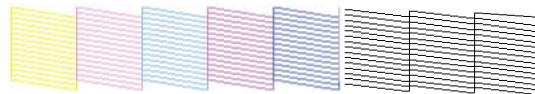

Print head needs cleaning

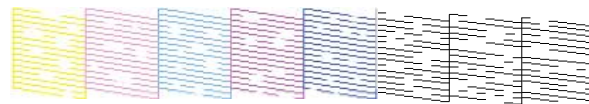

6. If there are no gaps, click **Finish**.

If there are gaps or the pattern is faint, clean the print head.

If you don't see any improvement after cleaning the print head up to 4 times, wait at least 6 hours. Then try cleaning the print head again. If quality still does not improve, one of the ink cartridges may be old or damaged and needs to be replaced.

Parent topic: [Print Head Nozzle Check](#)

Related tasks

[Cleaning the Print Head Using the Product Control Panel](#)

[Cleaning the Print Head Using a Computer Utility](#)

Print Head Cleaning

If print quality has declined and the nozzle check pattern indicates clogged nozzles, you can clean the print head.

Note: You cannot clean the print head if an ink cartridge is expended, and may not be able to clean it when a cartridge is low. You must replace the cartridge first.

[Cleaning the Print Head Using the Product Control Panel](#)

[Cleaning the Print Head Using a Computer Utility](#)



Parent topic: [Print Head Maintenance](#)

Related tasks

[Removing and Installing Ink Cartridges](#)

Cleaning the Print Head Using the Product Control Panel

You can clean the print head using the control panel on your product.

1. Press the  home button, if necessary.
2. Press the  setup button.

You see this screen:

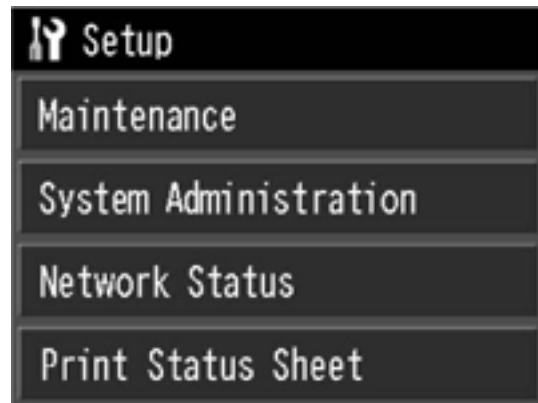

3. Select **Maintenance**.
4. Select **Print Head Cleaning**.
5. Load a few sheets of plain paper in the sheet feeder.
6. Select **Head Cleaning**.
7. Select **Print**.

When the cleaning cycle is finished, you see a message on the screen.

Caution: Never turn off the product during a cleaning cycle or you may damage it.

8. Select **Print Nozzle Check Pattern** and select **Print**.

9. Check the printed pattern to see if there are gaps in the lines.

Print head is clean

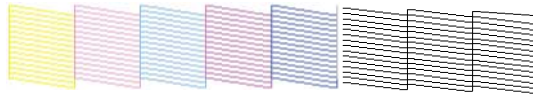

Print head needs cleaning

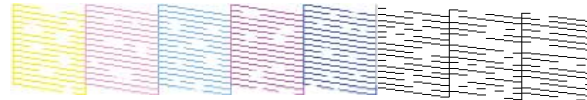

- If there are no gaps, select **Done**.
 - If there are gaps or the pattern is faint, select **Clean the Print Head** and continue.
10. Follow the instructions on the screen to clean the print head, check the nozzles, and repeat the process as necessary.

If you don't see any improvement after cleaning the print head up to 4 times, wait at least 6 hours. Then try cleaning the print head again. If quality still does not improve, one of the ink cartridges may be old or damaged and needs to be replaced.

Parent topic: [Print Head Cleaning](#)

Related tasks

[Removing and Installing Ink Cartridges](#)

[Cleaning the Print Head Using a Computer Utility](#)

[Checking the Nozzles Using the Product Control Panel](#)

Cleaning the Print Head Using a Computer Utility

You can clean the print head using a utility on your Windows computer or Mac.

1. Load a few sheets of plain paper in the sheet feeder.
2. Do one of the following:
 - **Windows:** Access the Windows Desktop and right-click the product icon in the Windows taskbar.

- In the Apple menu or the Dock, select **System Preferences**. Select **Print & Fax**, **Print & Scan**, or **Printers & Scanners**, select your product, and select **Options & Supplies**. Select **Utility** and select **Open Printer Utility**.
3. Select **Head Cleaning**.

You see a window like this:

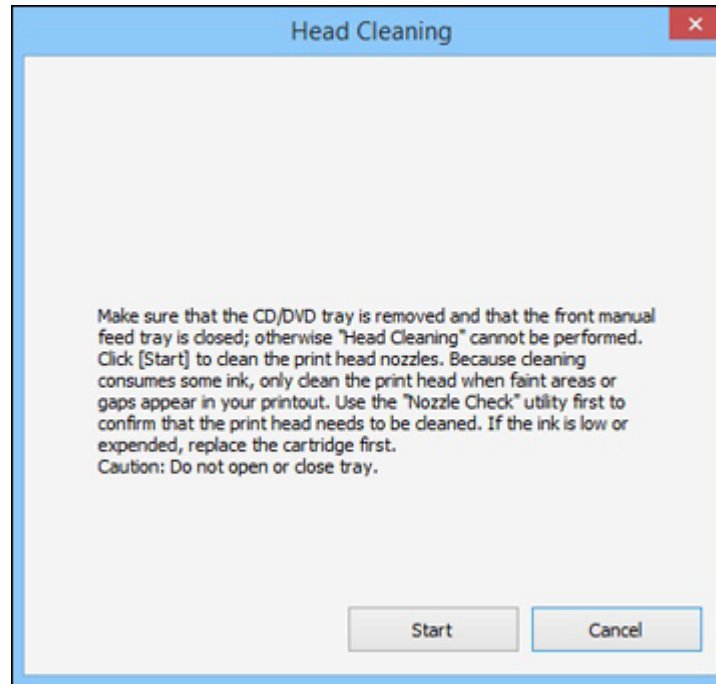

4. Click **Start** to begin the cleaning cycle.
- The  power light flashes throughout the cleaning cycle and stays on when the cleaning cycle is finished.
- Caution:** Never turn off the product during a cleaning cycle or you may damage it.
5. When the cleaning cycle is finished, you can check to see if the nozzles are clean; click **Print Nozzle Check Pattern** and click **Print**.

6. Check the printed pattern to see if there are gaps in the lines.

Print head is clean

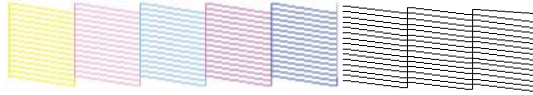

Print head needs cleaning

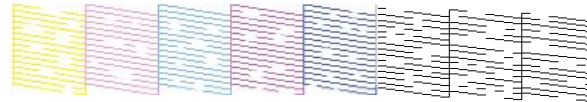

- If there are no gaps, click **Finish**.
- If there are gaps or the pattern is faint, click **Clean** to clean the print head again.

If you don't see any improvement after cleaning the print head up to 4 times, wait at least 6 hours. Then try cleaning the print head again. If quality still does not improve, one of the ink cartridges may be old or damaged and needs to be replaced.

Parent topic: [Print Head Cleaning](#)

Related tasks

[Removing and Installing Ink Cartridges](#)

Print Head Alignment

If your printouts become grainy or blurry, you notice misalignment of vertical lines, or you see dark or light horizontal bands, you may need to align the print head.

Note: Banding may also occur if your print head nozzles need cleaning.



[Aligning the Print Head Using the Product Control Panel](#)

[Aligning the Print Head Using a Computer Utility](#)

Parent topic: [Adjusting Print Quality](#)

Aligning the Print Head Using the Product Control Panel

You can align the print head using the control panel on your product.

1. Press the  home button, if necessary.
2. Press the  setup button.

You see this screen:

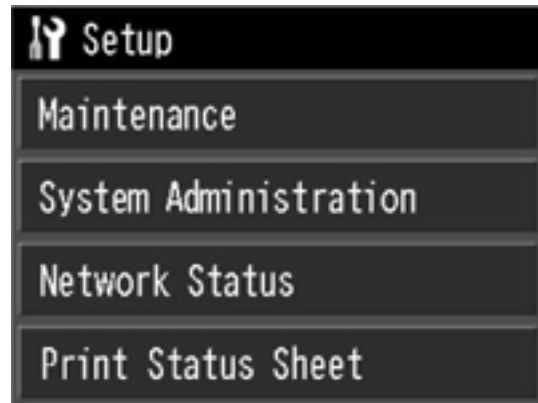

3. Select **Maintenance**.
4. Press the down arrow and select **Head Alignment**.
5. Load a few sheets of plain paper in the sheet feeder.
6. Select **Print** to print an alignment sheet.

Note: Do not cancel printing while you are printing head alignment patterns.

After the alignment sheet is printed, you see a series of screens asking you to select the best square in each pattern set.

7. Check the printed patterns and choose the number representing the best square for each set, then select **Proceed**.
8. After you have selected the number for all the sets, select **Done**.

Parent topic: [Print Head Alignment](#)

Aligning the Print Head Using a Computer Utility

You can align the print head using a utility on your Windows computer or Mac.

1. Load a few sheets of plain paper in the sheet feeder.
2. Do one of the following:
 - **Windows:** Access the Windows Desktop and right-click the product icon in the Windows taskbar.
 - In the Apple menu or the Dock, select **System Preferences**. Select **Print & Fax**, **Print & Scan**, or **Printers & Scanners**, select your product, and select **Options & Supplies**. Select **Utility** and select **Open Printer Utility**.
3. Select **Print Head Alignment**.

You see a window like this:

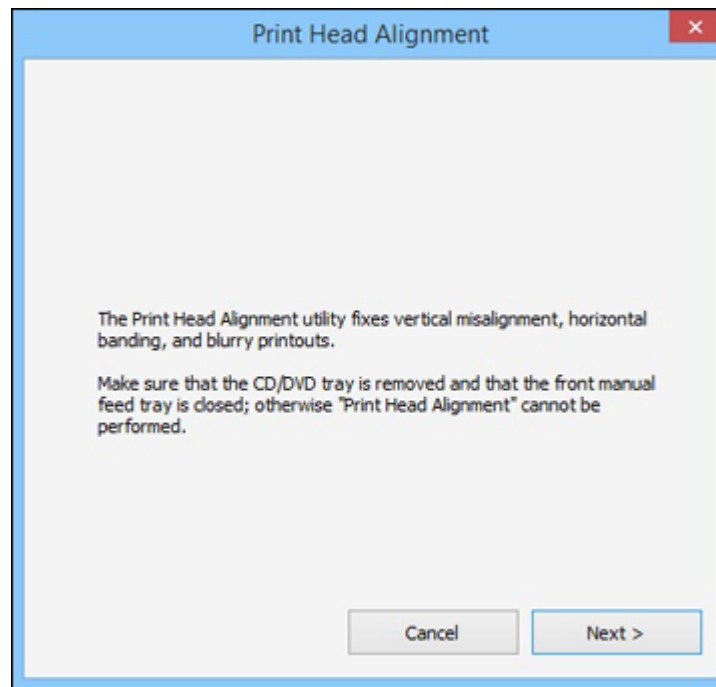

4. Click **Next** then click **Print** to print an alignment sheet.

Note: Do not cancel printing while you are printing a head alignment pattern.

You see a window like this:

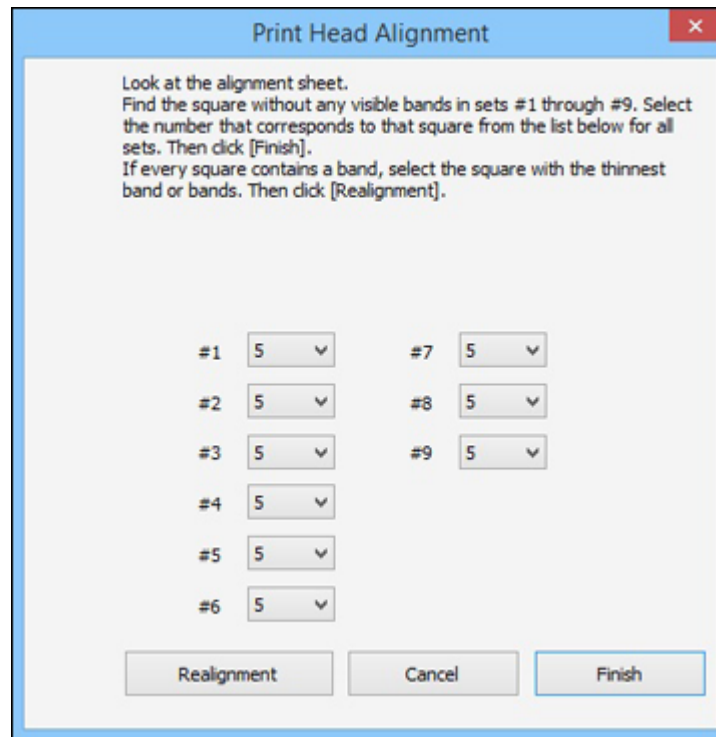

5. Check the printed pattern and follow the instructions on the screen to choose the number representing the best printed pattern for each set.
 - After choosing each pattern number, click **Next**.
 - If no patterns are aligned in one or more of the sets, choose the closest one in each set and click **Realignment**. Then print another alignment sheet and check it.



Note: Click **Skip** (where available) if you want to skip a particular alignment sheet.

6. When you are done, click **Finish**.

Parent topic: [Print Head Alignment](#)

Cleaning the Paper Guide

If you see ink on the back of a printout, you can clean the paper guide rollers to remove any excess ink.

1. Load several sheets of plain paper (or a cleaning sheet) in the sheet feeder.
2. Press the  home button, if necessary.
3. Press the  setup button.

You see this screen:

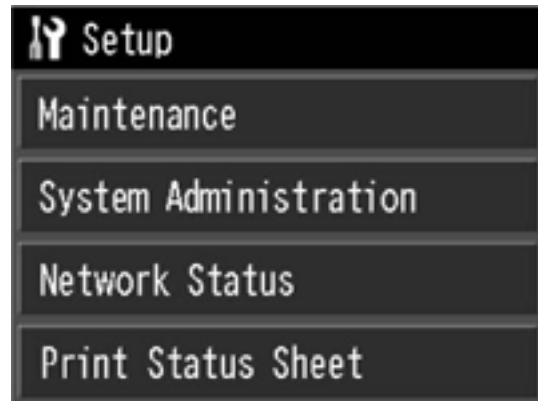

4. Select **Maintenance**.
5. Select **Paper Guide Cleaning**.
6. Select **Roller Cleaning**.
The paper feeds through your product.
7. Repeat these steps as necessary until no ink appears on the back of your printouts.

Parent topic: [Adjusting Print Quality](#)

Cleaning and Transporting Your Product

See these sections if you need to clean or transport your product.

[Cleaning Your Product](#)

[Transporting Your Product](#)

Cleaning Your Product

To keep your product working at its best, you should clean it several times a year.

Caution: Do not use a hard brush, benzene, alcohol, or paint thinner to clean the product or you may damage it. Do not place anything on top of the cover or use the cover as a writing surface, or it could get permanently scratched. Do not use oil or other lubricants inside the product or let water get inside.

1. Turn off the product.
2. Unplug the power cable.
3. Disconnect any connected cables.
4. Remove all the paper and the roll paper holders from the product.
5. Clean the paper support and manual feed tray using a soft brush or a dry microfiber cloth.
6. Close the paper support, manual feed tray, output tray, and any covers.
7. Clean the outer case with a soft cloth dampened with a mild detergent.
8. Plug the power cable back in and turn on the product.
9. Load several sheets of plain paper (or a cleaning sheet) in the sheet feeder and clean the paper guide.

Close the rear paper support and output tray when you are not using the product to help keep it clean.

Parent topic: [Cleaning and Transporting Your Product](#)

Transporting Your Product

If you need to store your product or transport it a long distance, prepare it for transportation as described here.

Caution: During transportation and storage, follow these guidelines:

- Avoid tilting the product, placing it vertically, or turning it upside down; otherwise ink may leak.

- Leave the ink cartridges installed. Removing the cartridges can dry out the print head and may prevent the product from printing.

1. Turn off the product.
2. Unplug the power cable.
3. Disconnect any connected cables.
4. Remove all the paper from the product.
5. Remove the roll paper holders.
6. Close the rear paper support and the output tray.
7. Open the printer cover.

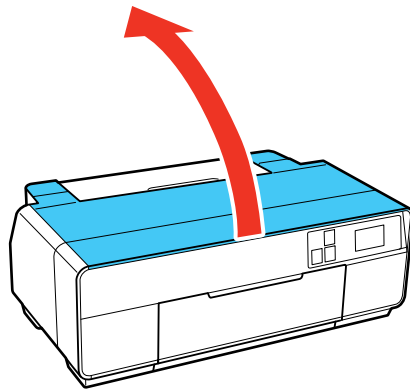

8. If you changed the control panel angle, push it down to return it to its original position.

- Secure the ink cartridge holder to the case with tape. Leave the ink cartridges installed to avoid damaging the product.

Note: Some tape may be difficult to remove if left in place for a long time. Remove the tape immediately after transporting the product.

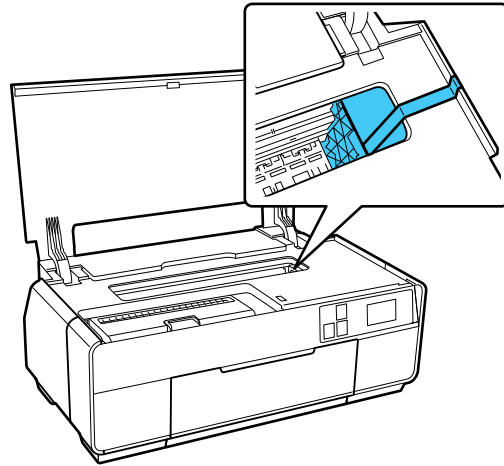

- Close the printer cover.
- Open the front cover.

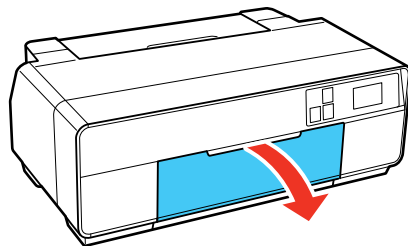

12. Attach the transportation lock that comes with your product to the lower right of the front manual feed tray and secure it with tape.

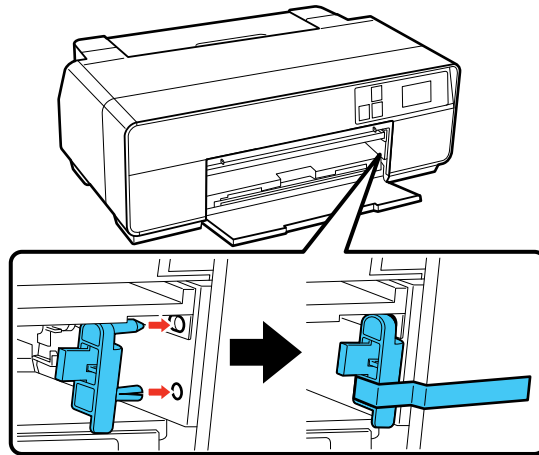

13. Attach the transportation lock shown here to the top of the front manual feed tray and secure it with tape.

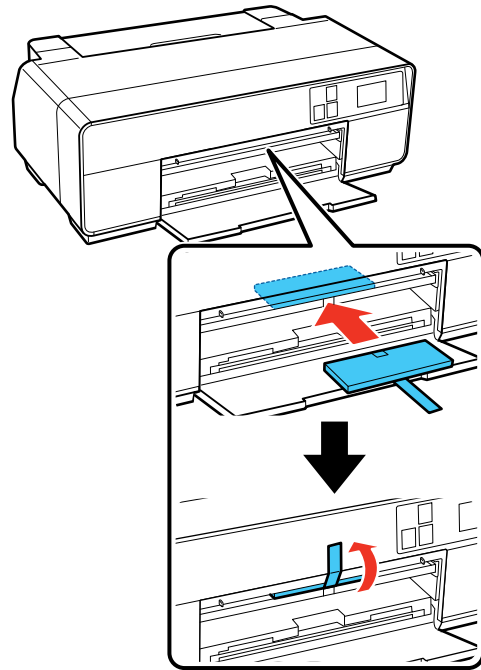

14. Attach the transportation lock shown here to the bottom of the front manual feed tray and secure it with tape.

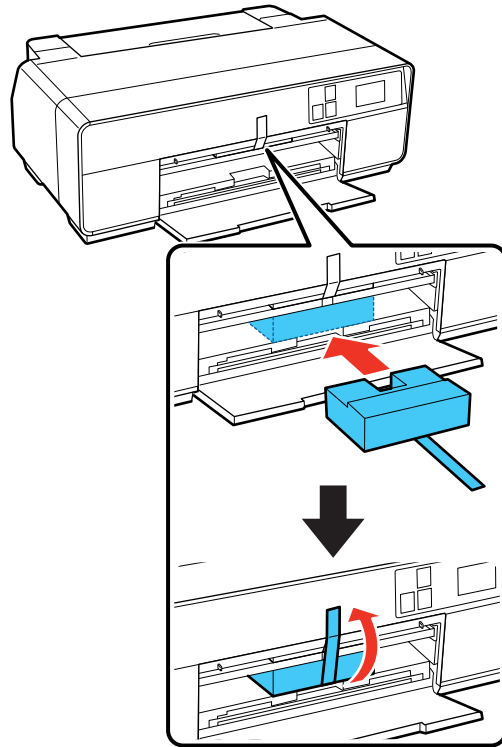

15. Close the front cover and secure it with tape.

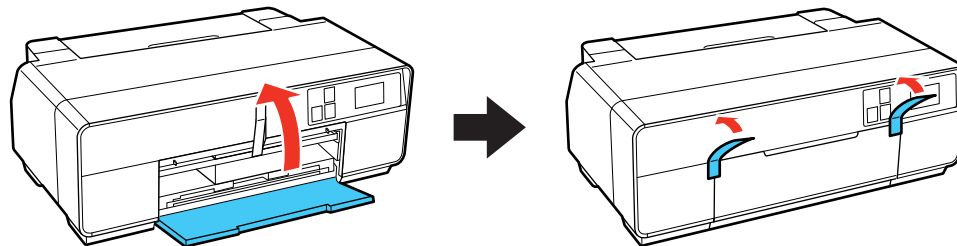

16. Place the product in its original packing materials, if possible, or use equivalent materials with cushioning around the product. Make sure the box adequately protects the product control panel.

17. After unpacking the product, be sure to remove all of the tape.

Keep the product level during transportation. If print quality has declined when you print again, clean and align the print head.

Parent topic: [Cleaning and Transporting Your Product](#)

Related concepts

[Print Head Cleaning](#)

[Print Head Alignment](#)

Solving Problems

Check these sections for solutions to problems you may have using your product.

[Checking for Software Updates](#)

[Product Status Messages](#)

[Running a Product Check](#)

[Resetting Control Panel Defaults](#)

[Solving Setup Problems](#)

[Solving Network Problems](#)

[Solving Paper Problems](#)

[Solving Problems Printing from a Computer](#)

[Solving Page Layout and Content Problems](#)

[Solving Print Quality Problems](#)

[Solving CD/DVD Problems](#)

[Uninstall Your Product Software](#)

[Where to Get Help](#)

Checking for Software Updates

Periodically, it's a good idea to check Epson's support website for free updates to your product software. Visit the driver download site at ([U.S. downloads](#) or [Canadian downloads](#)).

- **Windows:** Your printer software automatically checks for updates. You can also manually update the software by:
 - Accessing the Windows Desktop, right-clicking the product icon in the Windows taskbar, then clicking **Software Update**.
 - Clicking on the **Utility** tab in the printer settings window and selecting **Driver Update**

You can also update the software by selecting **EPSON Software Updater** in the **EPSON** or **EPSON Software** program group, accessible by the **Start** button, or on the **Start** or **Apps** screens, depending on your version of Windows.

- **OS X:** You can manually update the software by opening the **Applications > Epson Software** folder and selecting **EPSON Software Updater**.

Parent topic: [Solving Problems](#)

Product Status Messages

You can often diagnose problems with your product by checking the messages on its LCD screen.

Note: If the LCD screen is dark, press the screen to wake the product from sleep mode.

LCD screen message	Condition/solution
Close the printer cover. See your documentation for details.	Paper may be jammed in the product. If paper is jammed in the product, follow the instructions in this guide to remove the jammed paper from the indicated area.
Printer Error. Turn power off and then on again. For details, see your documentation.	A serious error has occurred. Turn the product off and then back on again. If the error continues, check for a paper jam. If there is no paper jam, contact Epson for support.
A printer's ink pad is nearing the end of its service life. Please contact Epson Support.	The ink pads are near the end of their service life and the message will be displayed until the ink pad is replaced. Contact Epson to replace ink pads before the end of their service life.
A printer's ink pad is at the end of its service life. Please contact Epson Support.	The ink pad is at the end of its service life. Turn off the product and contact Epson for support.
Combination of IP address and subnet mask is invalid. See your documentation.	There is a problem with the network configuration of your product.
Some functions may not be available. For details, see your documentation.	When Paper Setup Display is set to Off , the Error Notice setting automatically defaults to Off and AirPrint is not available. Set the Paper Setup Display setting to On to use AirPrint.

Note: The ink pads in the printer collect, distribute, and contain the ink that is not used on printed pages. During the life of your product it may reach a condition where either satisfactory print quality cannot be maintained or the ink pads have reached the end of their usable life. The Epson Status Monitor, your LCD, or lights on the control panel will advise you when these parts need replacing. If this happens during the standard warranty of the product, the exchange of the product or replacement of the pads is covered under the standard warranty. If the product is out of warranty, the pads can be replaced by any Epson authorized service provider. The waste ink pads are not a user-replaceable part.

Parent topic: [Solving Problems](#)

Related references

[Paper Jam Problems in the Sheet Feeder](#)
[Paper Jam Problems in the Front Manual Feed Tray](#)
[Paper Jam Problems - Thick Media](#)
[Paper Jam Problems - Roll Paper](#)
[CD/DVD Jam Problems](#)
[Where to Get Help](#)

Related tasks



[Checking for Software Updates](#)

Related topics

[Replacing Ink Cartridges](#)
[Wi-Fi or Wired Networking](#)
[Loading Media](#)

Running a Product Check

Running a product check helps you determine if your product is operating properly.

1. Disconnect any interface cables connected to your product.
2. Make sure plain paper is loaded in the sheet feeder.
3. Press the  home button, if necessary.
4. Press the  setup button.

You see this screen:

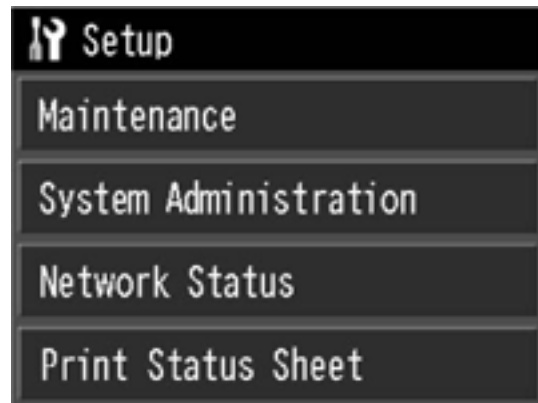

5. Select **Maintenance**.
6. Select **Print Head Nozzle Check**.
7. Select **Print**.
The nozzle pattern prints.
8. Do one of the following, depending on the results of the product check:
 - If the page prints and the nozzle check pattern is complete, the product is operating properly. Any operation problem you may have could be caused by your computer, cable, software, or selected settings. Check the other solutions in this manual or try uninstalling and reinstalling your printer software.
 - If the page prints but the nozzle check pattern has gaps, clean or align the print head.
 - If the page does not print, the product may have a problem. Check the other solutions in this manual. If they do not work, contact Epson.

Parent topic: [Solving Problems](#)

Related concepts

[Print Head Cleaning](#)

[Print Head Alignment](#)



[Uninstall Your Product Software](#)

Related references

[Where to Get Help](#)

Resetting Control Panel Defaults

If you have a problem with settings on the product control panel, you can reset them to their factory defaults. You can choose which settings to reset or reset them all.

1. Press the  home button, if necessary.
2. Press the  setup button.

You see this screen:

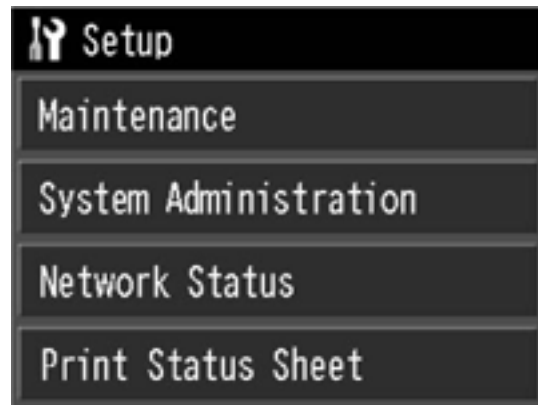

3. Select **System Administration**.
4. Press the down arrow button and select **Restore Default Settings**.
5. Select one of these options:
 - **Network Settings**: Resets all network settings.
 - **All except Network Settings**: Resets all except network settings.
 - **All Settings**: Resets all control panel settings.

You see a confirmation screen.

6. Select **Yes** to reset the selected settings. (Select **No** if you want to cancel the operation.)

Parent topic: [Solving Problems](#)

Solving Setup Problems

Check these sections if you have problems while setting up your product.

[Noise After Ink Installation](#)

[Software Installation Problems](#)

Parent topic: [Solving Problems](#)

Noise After Ink Installation

If you hear noises from your product after installing ink, check the following:

- The first time you install ink cartridges, the product must charge its print head. Wait until charging finishes before you turn off the product, or it may charge improperly and use excess ink the next time you turn it on. Your product is finished charging the print head when the ⏻ power light stops flashing.
- If the product's print head stops moving or making noise, and the charging process has not finished after approximately 5 minutes, turn off your product. Turn it back on and check to see if charging is still in progress. If it is still in progress, contact Epson for help.
- Turn off the product, then make sure the ink cartridges are inserted completely and the ink cartridge cover is closed completely. Also make sure no packing material remains in the product. Wait a moment, then turn the product back on to clear the error.

Parent topic: [Solving Setup Problems](#)

Software Installation Problems

If you have problems while installing your product software, try these solutions:

- Make sure your product is turned on and any necessary cables are securely connected at both ends. If you still have problems installing software, disconnect the cable and carefully follow the instructions on the *Start Here* sheet. Also make sure your system meets the requirements for your operating system.
- Close any other programs, including screen savers and virus protection software, and install your product software again.
- In Windows, make sure your product is selected as the default printer and the correct port is shown in the printer properties.
- If you see any error message or your software does not install correctly in Windows, you may not have software installation privileges. Contact your System Administrator.
- If you are printing over a network, make sure your product is set up properly on the network.

Parent topic: [Solving Setup Problems](#)

Related concepts

[Uninstall Your Product Software](#)

Related references

[Windows System Requirements](#)

[OS X System Requirements](#)

Solving Network Problems

Check these solutions if you have problems setting up or using your product on a network.

Note: Breakdown or repair of this product may cause loss of network data and settings. Epson is not responsible for backing up or recovering data and settings during or after the warranty period. We recommend that you make your own backup or print out your network data and settings.

[Product Cannot Connect to a Wireless Router or Access Point](#)

[Network Software Cannot Find Product on a Network](#)

[Product Does Not Appear in OS X Printer Window](#)

[Cannot Print Over a Network](#)

Parent topic: [Solving Problems](#)

Product Cannot Connect to a Wireless Router or Access Point

If your product has trouble finding or connecting to a wireless router or access point, try these solutions:

- If you are connecting the product via Wi-Fi Protected Setup (WPS) and the Wi-Fi icon on your product's LCD screen is not lit or does not appear, make sure you select one of the WPS options from the product control panel within 2 minutes of pressing the WPS button on your router.
- Make sure to place your product within contact range of your 2.4 GHz router or access point. Avoid placing your product near a microwave oven, 2.4 GHz cordless phone, or large metal object, such as a filing cabinet.

Note: If you are using a 5 GHz wireless router, set the router to operate in dual band (2.4 GHz and 5 GHz) mode. See your router documentation for instructions.

- Verify that your router or access point is operating correctly by connecting to it from your computer or another device.
- You may need to disable the firewall and any anti-virus software on your wireless router or access point.
- Check to see if access restrictions, such as MAC address filtering, are set on the router or access point. If access restrictions are set, add your product's MAC address to your router's address list. To obtain your product's MAC address, print a network status sheet. Then follow the instructions in your router or access point documentation to add the address to the list.
- If your router or access point does not broadcast its network name (SSID), follow the instructions that came with your product to enter your wireless network name manually.

- If your router or access point has security enabled, determine the kind of security it is using and any required password or passphrase for connection. Then make sure to enter the exact WEP key or WPA passphrase correctly.
- Check if your computer is restricting the available wireless channels. If so, verify that your wireless access point is using one of the usable channels and change to a usable channel, if necessary.
- If you are using a Wi-Fi Direct connection that suddenly disconnects, the Wi-Fi direct password on your device may have been changed. If necessary, delete the existing **DIRECT-xxxxxxx** connection settings from your device and enter a new password. See your device documentation for instructions.
- If you connected your product to a Windows computer using Wi-Fi Direct and it automatically selected Access Point Mode, you may have trouble accessing a low-priority Internet connection. Check the network connection or adapter settings in the Windows Control Panel and set the **Internet metric** setting to **100** for your version of the Internet Protocol.

Parent topic: [Solving Network Problems](#)

Related concepts

[Wi-Fi Direct Mode Setup](#)

Related tasks

[Printing a Network Status Sheet](#)

[Selecting Wireless Network Settings from the Control Panel](#)

Related topics

[Wi-Fi or Wired Networking](#)

Network Software Cannot Find Product on a Network

If EpsonNet Setup cannot find your product on a network, try these solutions:

- Make sure your product is turned on and connected to your network. Verify connection using your product control panel.
- Check if your network name (SSID) contains non-ASCII characters. Your product cannot display non-ASCII characters.
- Make sure your product is not connected to a guest network.
- If necessary, reinstall your product software and try running EpsonNet Setup again:
 1. Reset your product's network settings to their factory defaults.
 2. Windows only: uninstall your product software.
 3. Initialize your router following the instructions in your router documentation.

Note: If you are reading these instructions online, you will lose your Internet connection when you initialize your router, so note the next step before initializing it.

4. Download your product software from the Epson website using the instructions on the *Start Here* sheet.
- If you have replaced your router, reinstall your product software to connect to the new router.

Note: If you are using a 5 GHz wireless router, set the router to operate in dual band (2.4 GHz and 5 GHz) mode. See your router documentation for instructions.

Parent topic: [Solving Network Problems](#)

Related concepts

[Uninstall Your Product Software](#)

Related topics

[Wi-Fi or Wired Networking](#)

Product Does Not Appear in OS X Printer Window

If your product does not appear in the OS X printer window, try these solutions:

- Turn your product off, wait 30 seconds, then turn it back on again.
- If you are connecting the product wirelessly via EpsonNet Setup and a WiFi symbol is not displayed on the product's LCD screen, make sure your product software was installed correctly. If necessary, reinstall your software.
- Make sure you installed your product software correctly for your network. See the *Start Here* sheet for instructions.
- If your Mac includes both wired and wireless network services, make sure the network to which you connected your product is at the top of the Set Service Order list. Check your Mac documentation for instructions.

Note: If you are using a 5 GHz wireless router, set the router to operate in dual band (2.4 GHz and 5 GHz) mode. See your router documentation for instructions.

Parent topic: [Solving Network Problems](#)

Related concepts

[Uninstall Your Product Software](#)

Cannot Print Over a Network

If you cannot print over a network, try these solutions:

- Make sure that your product is turned on.
- Make sure you install your product's network software as described in your product documentation.
- Print a network status sheet and verify that the network settings are correct. If the network status is **Disconnected**, check any cable connections and turn your product off and then on again.
- If you are using TCP/IP, make sure the product's IP address is set correctly for your network. If your network does not assign IP addresses using DHCP, set the IP address manually.
- Make sure your computer and product are both using the same wireless network.
- If network printing is slow, print a network status sheet and check the signal strength. If it is poor, place your product closer to your router or access point. Avoid placing your product near a microwave oven, 2.4 GHz cordless phone, or large metal object, such as a filing cabinet.

Note: If you are using a 5 GHz wireless router, set the router to operate in dual band (2.4 GHz and 5 GHz) mode. See your router documentation for instructions.

- Check to see if your wireless router or access point has an enabled Privacy Separator function that is preventing printing from a device over the network. See your router or access point documentation for instructions on disabling the Privacy Separator function.
- If you are connecting the product via Wi-Fi Protected Setup (WPS) and the Wi-Fi icon does not appear on your product's LCD screen, make sure you select one of the WPS options from the product control panel within 2 minutes of pressing the WPS button on your router.
- Check your wired LAN router or access point to see if the LED for the port to which your product is connected is on or flashing. If the link LED is off, try the following:
 - Make sure the Ethernet cable is securely connected to your product and to your router, access point, switch, or hub.
 - Try connecting your product to a different port or a different router, access point, switch, or hub.
 - Try connecting with a different Ethernet cable.
 - Try printing to your product from another computer on the network.

Note: If you are using a 5 GHz wireless router, set the router to operate in dual band (2.4 GHz and 5 GHz) mode. See your router documentation for instructions.

- If you are connecting the product via EpsonNet Setup and the Wi-Fi icon does not appear on the LCD, make sure your product software was installed correctly. If necessary, reinstall your software.

Parent topic: [Solving Network Problems](#)

Related concepts

[Uninstall Your Product Software](#)

Related tasks

[Printing a Network Status Sheet](#)

Related topics

[Wi-Fi or Wired Networking](#)

Solving Paper Problems

Check these sections if you have problems using paper with your product.

[Paper Feeding Problems](#)

[Paper Jam Problems in the Sheet Feeder](#)

[Paper Jam Problems in the Front Manual Feed Tray](#)

[Paper Jam Problems - Thick Media](#)

[Paper Jam Problems - Roll Paper](#)

[Paper Ejection Problems](#)

Parent topic: [Solving Problems](#)

Paper Feeding Problems

If you have problems feeding paper, try these solutions:

- If paper does not feed into the sheet feeder, remove the paper and fan the edges to separate the sheets. Reload paper against the right side and slide the edge guide against it. Do not load too many sheets in the sheet feeder at once and make sure the product cover is closed.
- When using the sheet feeder, do not load paper above the arrow mark on the left edge guide. Load only one sheet of compatible paper when using the front manual feed tray.
- Load only one sheet of media in the front manual feed tray. For posterboard, make sure there is enough space behind the product for the media to feed through.
- If multiple pages feed at once, remove the paper, fan the edges to separate the sheets, and reload it.
- If you can not insert paper easily into the front manual feed tray, make sure the paper is perfectly flat and not curled.

- If you are printing on roll paper or with the sheet feeder, make sure the manual feed tray is not extended. Extend it only to load fine art paper or posterboard. Once the media is fed into the product and you see a message on the LCD screen, close the manual feed tray.
- If paper loaded using the front manual feed tray does not feed, make sure you installed the paper correctly and guided it all the way into the product.
- Do not load more than the recommended number of sheets.
- Make sure paper is loaded in the correct orientation. Load cut sheets in the sheet feeder vertically.
- Make sure your paper meets the specifications for your product.
- If paper dust builds up on the rollers, they may lose traction and become unable to feed paper properly. Clean the paper guide.
- If roll paper does not feed, cut the end straight across and uncurl it by rolling it backward, if necessary. Then reload the paper.
- If thick media does not feed, make sure you are loading it straight into the product, not at an angle.
- Make sure the transportation lock is removed from the front manual feed tray.
- If paper jams when you print on both sides of the paper, try loading fewer sheets.
- For best results, follow these guidelines:
 - Use new, smooth, high-quality paper that is not damp, curled, creased, old, too thin, or too thick.
 - Load paper printable side up.
 - Follow any special loading instructions that came with the paper.

Parent topic: [Solving Paper Problems](#)

Related references

[Paper Jam Problems in the Sheet Feeder](#)

[Paper Jam Problems in the Front Manual Feed Tray](#)

[Paper Jam Problems - Thick Media](#)

[Paper Jam Problems - Roll Paper](#)

[Paper Ejection Problems](#)

[Cut Sheet Media Loading Capacity](#)

[Paper Specifications](#)

Related topics

[Loading Media](#)

Paper Jam Problems in the Sheet Feeder

If paper has jammed in the sheet feeder, try this solution:

1. Carefully remove any paper jammed in the sheet feeder or the front output area.

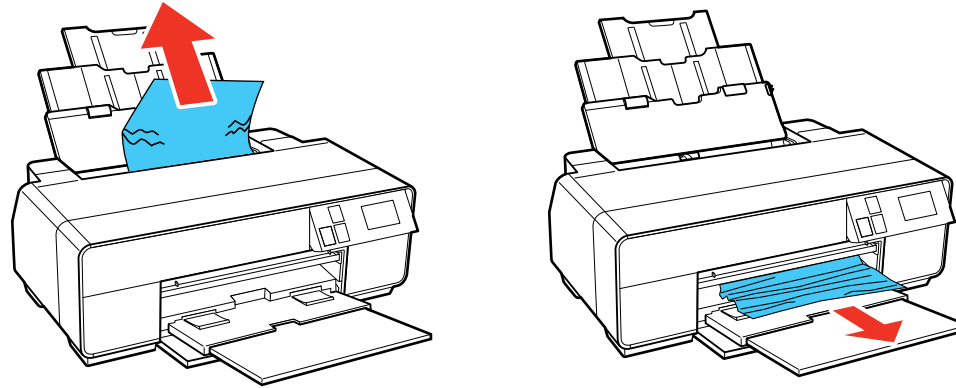

2. Open the printer cover and slowly pull any jammed paper out of the product.

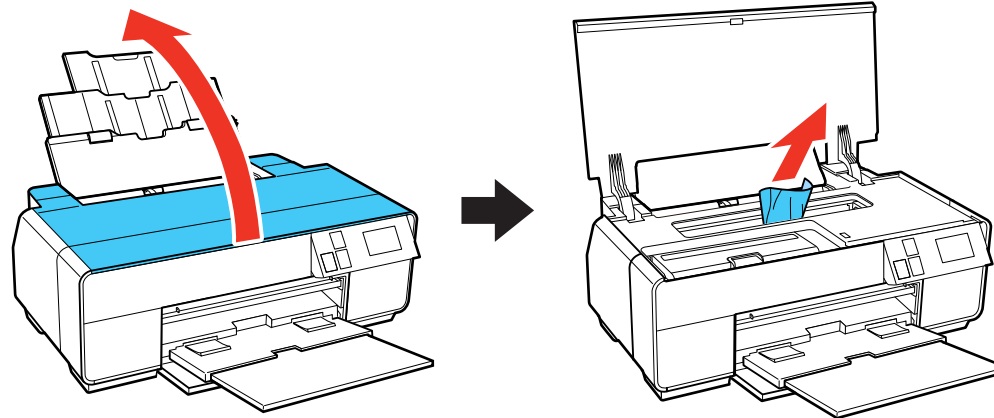

3. Close the printer cover and select **Restart**.
4. If an error is still displayed, turn off the product, then turn it back on.
5. If you are unable to remove the paper, contact Epson for support.

Parent topic: [Solving Paper Problems](#)

Related references

[Paper Jam Problems in the Front Manual Feed Tray](#)

[Paper Jam Problems - Thick Media](#)

[Paper Jam Problems - Roll Paper](#)

Paper Jam Problems in the Front Manual Feed Tray

If paper has jammed in the front manual feed tray, try these solutions:

1. Cancel the print job from your computer, if necessary.
2. Carefully remove the jammed paper from the front or back as shown (whichever is easier).

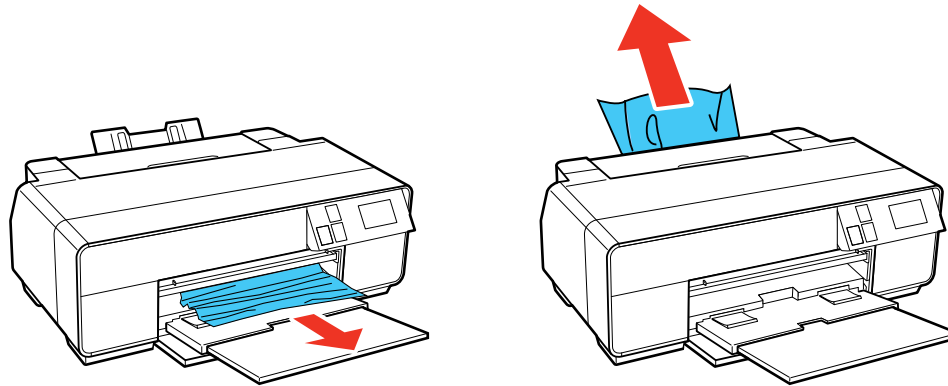

3. Open the printer cover and slowly pull any jammed paper out of the product.

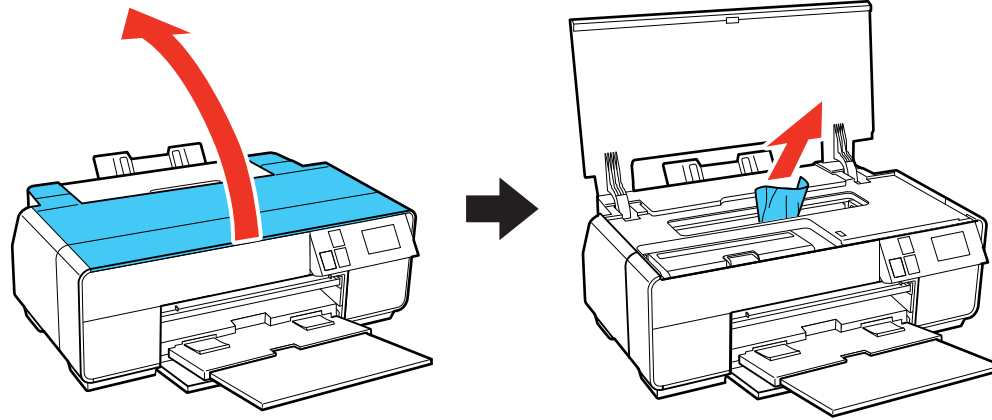

4. Close the printer cover and select **Restart**.

5. If an error is still displayed, turn off the product, then turn it back on.

6. If you are unable to remove the paper, contact Epson for support.

Parent topic: [Solving Paper Problems](#)

Related references

[Paper Jam Problems in the Sheet Feeder](#)

[Paper Jam Problems - Thick Media](#)

[Paper Jam Problems - Roll Paper](#)

Paper Jam Problems - Thick Media

If posterboard or other thick media has jammed inside the product, try these solutions:

1. Cancel the print job from your computer, if necessary.

2. Carefully remove the jammed paper from the front or back as shown (whichever is easier).

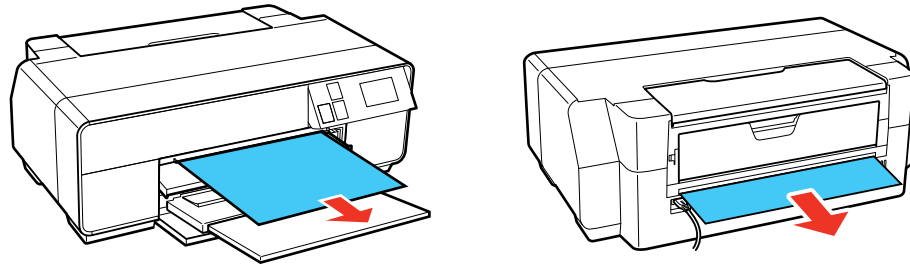

3. Open the printer cover and slowly pull any jammed paper out of the product.

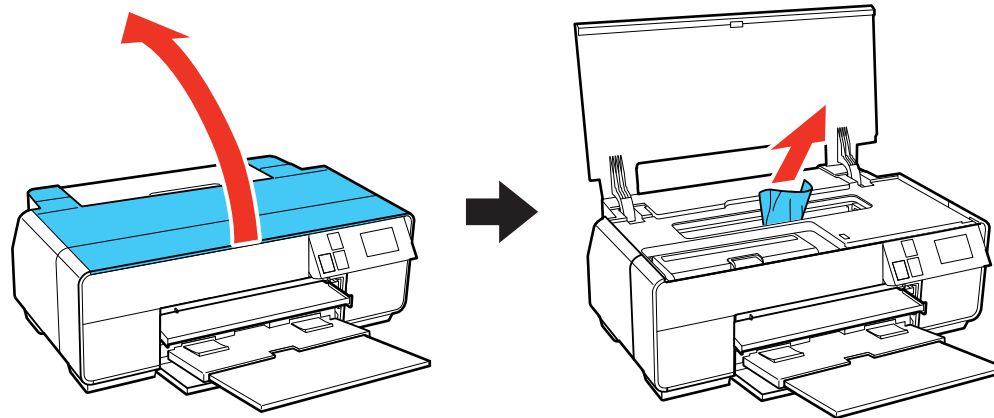

4. Close the printer cover and select **Restart**.

5. If an error is still displayed, turn off the product, then turn it back on.

6. If you are unable to remove the paper, contact Epson for support.

Parent topic: [Solving Paper Problems](#)

Related references

[Paper Jam Problems in the Sheet Feeder](#)

[Paper Jam Problems in the Front Manual Feed Tray](#)

[Paper Jam Problems - Roll Paper](#)

Paper Jam Problems - Roll Paper

If roll paper has jammed inside the product, try these solutions:

1. Cancel the print job from your computer, if necessary.
2. Cut the paper close to the roll paper feeder and the output tray as shown.

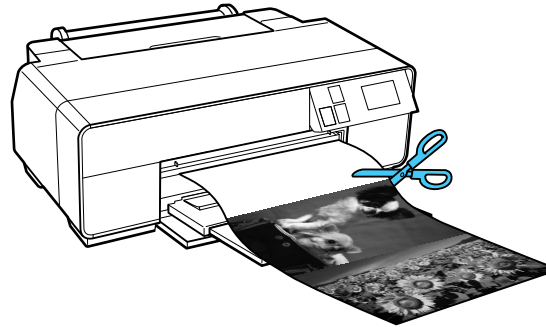
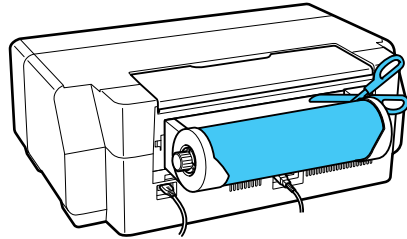

3. Carefully remove the jammed paper from the front or back as shown (whichever is easier).

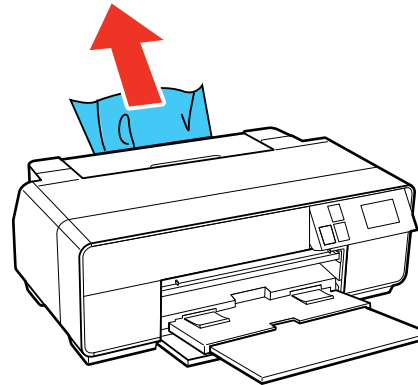
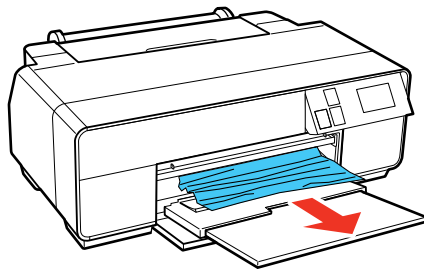

4. Open the printer cover and slowly pull any jammed paper out of the product.

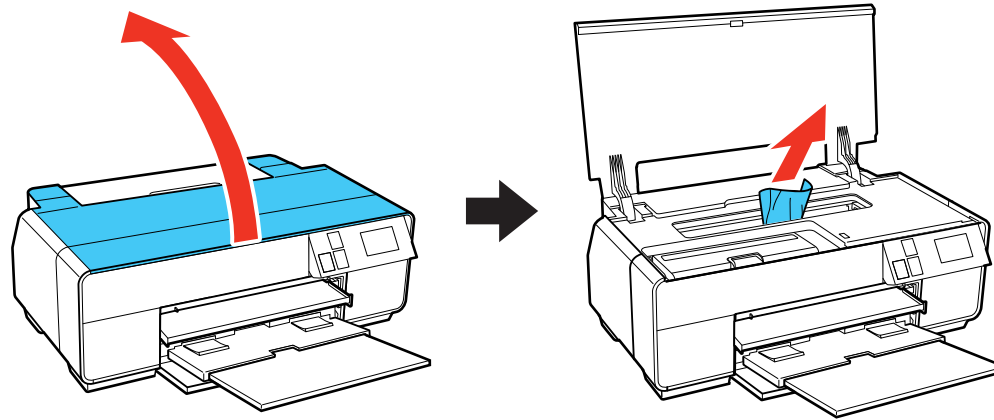

5. Close the printer cover and select **Restart**.

6. If an error is still displayed, turn off the product, then turn it back on.

7. If you are unable to remove the paper, contact Epson for support.

Parent topic: [Solving Paper Problems](#)

Related references

[Paper Jam Problems - Thick Media](#)

[Paper Jam Problems in the Sheet Feeder](#)

[Paper Jam Problems in the Front Manual Feed Tray](#)

Paper Ejection Problems

If you have problems with paper ejecting properly, try these solutions:

- If paper does not eject fully, you may have set the wrong paper size. Cancel printing using the product control panel, then select **Eject** or **Cut/Eject** (roll paper) to eject the paper. Remove any paper remaining in the product. Select the correct size when you reprint.
- If paper is wrinkled when it ejects, it may be damp or too thin. Load new paper and be sure to select the correct paper type setting in your printer software when you reprint.

Parent topic: [Solving Paper Problems](#)

Related references

[Paper Jam Problems in the Sheet Feeder](#)
[Paper Jam Problems in the Front Manual Feed Tray](#)
[Paper Jam Problems - Thick Media](#)
[Paper Jam Problems - Roll Paper](#)

Related tasks

[Selecting the Paper Settings for Each Source - Control Panel](#)
[Selecting the Default Paper Setup Display and Error Notice Settings](#)

Related topics

[Loading Media](#)

Solving Problems Printing from a Computer

Check these sections if you have problems while printing from your computer.

Note: When printing using AirPrint, the available print settings are different from those covered in this manual. See the Apple website for details.

[Nothing Prints](#)

[Product Icon Does Not Appear in Windows Taskbar](#)
[Error After Cartridge Replacement](#)
[Printing is Slow](#)

Parent topic: [Solving Problems](#)

Nothing Prints

If you have sent a print job and nothing prints, try these solutions:

- Make sure your product is turned on.
- Make sure any interface cables are connected securely at both ends.
- Make sure the interface specifications match the specifications for the printer and the computer.
- If you connected your product to a USB hub, make sure it is a first-tier hub. If it still does not print, connect your product directly to your computer instead of the hub.
- Run a product check to see if a test page prints. If the test page prints, check to see if your product software is installed correctly.
- In Windows, make sure your product is selected as the default printer.

- In Windows, make sure the printer port setting matches the printer connection port.
- In Windows, clear any stalled print jobs from the Windows Spooler:
 - **Windows 8.x:** Navigate to the **Apps** screen and select **Control Panel > Hardware and Sound > Devices and Printers**. Right-click your product name, select **See what's printing**, and select your product name again if necessary. Right-click the stalled print job, click **Cancel**, and click **Yes**.
 - **Windows 7:** Click  and select **Devices and Printers**. Right-click your product name, select **See what's printing**, and select your product name again, if necessary. Right-click the stalled print job, click **Cancel**, and click **Yes**.
- In OS X, make sure the printer is added to the printer list.

Parent topic: [Solving Problems Printing from a Computer](#)

Related tasks

[Running a Product Check](#)

Product Icon Does Not Appear in Windows Taskbar

If you do not see your product icon in the Windows taskbar, first try restarting your computer. If that does not work, try this solution:

1. Do one of the following:
 - **Windows 8.x:** Navigate to the **Apps** screen and select **Control Panel > Hardware and Sound > Devices and Printers**.
 - **Windows 7:** Click  and select **Devices and Printers**.
2. Right-click your product name, select **Printing Preferences**, and select your product name again if necessary.
3. Click the **Utility** tab.
4. Click the **Monitoring Preferences** button.
5. Click the checkbox for the option that adds the shortcut icon to the taskbar.
6. Click **OK** to close the open program windows.

Parent topic: [Solving Problems Printing from a Computer](#)

Error After Cartridge Replacement

If you see an error message after you replace an ink cartridge, follow these steps:

1. Remove and reinsert the replaced ink cartridge, making sure to push it all the way into its slot.

2. Complete the ink cartridge installation steps.

Parent topic: [Solving Problems Printing from a Computer](#)

Printing is Slow

If printing becomes slow, try these solutions:

- Make sure your system meets the requirements for your operating system. If you are printing a high-resolution image, you may need more than the minimum requirements. If necessary, increase your system's memory.
- If you are using Windows 7, close the **Devices and Printers** window before you print.
- If you are using OS X, make sure you download and install the Epson printer driver.
- Clear space on your hard drive or run a defragmentation utility to free up existing space.
- Close any programs you are not using when you print.
- If your product is connected to a USB hub, connect it directly to your computer instead.
- If printing becomes slower after printing continuously for a long time, the product may have automatically slowed down to protect the print mechanism from overheating or becoming damaged. Let the product rest with the power on for 30 minutes, then try printing again.

For the fastest printing, select the following settings in your product software:

- Make sure the paper type setting matches the type of paper you loaded.
- Turn on any high speed settings in your product software.
- Select a lower print quality setting.
- **Windows:** Click the **Maintenance** or **Utility** tab, select **Extended Settings** or **Speed and Progress**, and select the following settings:
 - **High Speed Copies**
 - **Always Spool RAW Datatype**
 - **Page Rendering Mode**
 - **Print as Bitmap**

Parent topic: [Solving Problems Printing from a Computer](#)

Related references

[Paper or Media Type Settings - Control Panel](#)

[Paper or Media Type Settings - Product Software](#)

[Windows System Requirements](#)

[OS X System Requirements](#)

Related tasks

[Selecting Basic Print Settings - Windows](#)

[Selecting Additional Settings - Windows](#)

[Selecting Basic Print Settings - OS X](#)

Solving Page Layout and Content Problems

Check these sections if you have problems with the layout or content of your printed pages.

Note: When printing using AirPrint, the available print settings are different from those covered in this manual. See the Apple website for details.

[Inverted Image](#)

[Too Many Copies Print](#)

[Blank Pages Print](#)

[Incorrect Margins on Printout](#)

[Border Appears on Borderless Prints](#)

[Incorrect Characters Print](#)

[Incorrect Image Size or Position](#)

[Slanted Printout](#)

Parent topic: [Solving Problems](#)

Inverted Image

If your printed image is inverted unexpectedly, try these solutions:

- Turn off any mirror or inversion settings in your printing application.
- Turn off the **Mirror Image**, **Flip horizontally**, or **Reverse page orientation** settings in your printer software. (This option has different names, depending on your operating system version.)

Note: Leave these options turned on when you print on Epson Iron-on Cool Peel Transfer paper, if available for your product.

Parent topic: [Solving Page Layout and Content Problems](#)

Related tasks

[Selecting Print Layout Options - Windows](#)

[Selecting Additional Settings - Windows](#)

[Selecting Basic Print Settings - OS X](#)

Too Many Copies Print

Make sure that the **Copies** setting in your printing program or printer software is not set for multiple copies.

Parent topic: [Solving Page Layout and Content Problems](#)

Related tasks

[Selecting Print Layout Options - Windows](#)

[Selecting Additional Settings - Windows](#)

[Selecting Basic Print Settings - OS X](#)

Blank Pages Print

If blank pages print unexpectedly, try these solutions:

- Make sure you selected the correct paper size settings in your printing program and printer software.
- If a blank page exists in a document you are printing and you want to skip printing it, select the **Skip Blank Page** setting in your printer software, if available.
- Run a print head nozzle check to see if any of the nozzles are clogged. Then clean the print head, if necessary.
- Make sure your product is selected as the printer in your printing program.

Parent topic: [Solving Page Layout and Content Problems](#)

Related concepts

[Print Head Nozzle Check](#)

[Print Head Cleaning](#)

Related tasks

[Selecting Basic Print Settings - Windows](#)

[Selecting Additional Settings - Windows](#)

[Selecting Basic Print Settings - OS X](#)

[Selecting Printing Preferences - OS X](#)

Incorrect Margins on Printout

If your printed page has incorrect margins, try these solutions:

- Make sure you selected the correct paper size settings in your printing program and printer software.
- Make sure you selected the correct margins for your paper size in your printing program.
- Make sure your paper is positioned correctly for feeding into the printer.

You can use the preview option in your printer software to check your margins before you print.

Parent topic: [Solving Page Layout and Content Problems](#)

Related tasks

[Selecting Basic Print Settings - Windows](#)

[Selecting Basic Print Settings - OS X](#)

Related topics

[Loading Media](#)

Border Appears on Borderless Prints

If you see a border on borderless prints, try these solutions:

- Make sure you are printing on a compatible borderless paper type and size.

Note: For custom paper sizes, make sure you select a supported borderless page width.

- **Windows:** Make sure you selected the **Borderless** setting in your printer software.
- **OS X:** Make sure you selected the **Borderless** checkbox or a paper size with a **Borderless** option in your printer software.
- Adjust the **Expansion** setting to adjust the amount of image expansion on the edges of borderless prints.
- Make sure the image size and the paper size are set correctly; if the image is small, the enlargement may not be enough to cover the paper.

Parent topic: [Solving Page Layout and Content Problems](#)

Incorrect Characters Print

If incorrect characters appear in your prints, try these solutions before reprinting:

- Make sure any cables are securely connected at both ends.

- In Windows, delete all jobs from the Windows Spooler. Click **Print Queue** on the Utility tab in the printer settings window, and cancel any stalled print jobs.
- If your product is connected to a USB hub, connect it directly to your computer instead.
- If incorrect characters still appear in your prints, try connecting your product using a different cable.

Parent topic: [Solving Page Layout and Content Problems](#)

Incorrect Image Size or Position

If your printed image is the wrong size or in the wrong position, try these solutions:

- Make sure you selected the correct paper size and layout settings in your printing program and printer software.
- Make sure you selected the correct paper size on the control panel.
- Make sure your paper is positioned correctly for feeding into the printer.

You can use the preview option in your printer software to check your margins before you print.

Parent topic: [Solving Page Layout and Content Problems](#)

Related tasks

[Selecting Basic Print Settings - Windows](#)

[Selecting Additional Settings - Windows](#)

[Selecting Basic Print Settings - OS X](#)

[Selecting Printing Preferences - OS X](#)

Slanted Printout

If your printouts are slanted, try these solutions:

- Slide the edge guide against the edge of the paper.
- Make sure the paper support edge guide is flipped down.
- Select a higher print quality setting in your printer software.
- Turn off any high speed settings in your product software.
- Align the print head.
- Make sure the product is not printing while tilted or at an angle.

Parent topic: [Solving Page Layout and Content Problems](#)

Related tasks

[Selecting Basic Print Settings - Windows](#)

[Selecting Basic Print Settings - OS X](#)

Related topics

[Loading Media](#)

Solving Print Quality Problems

Check these sections if your printouts have problems with print quality, but your image looks fine on your computer screen.

Note: When printing using AirPrint, the available print settings are different from those covered in this manual. See the Apple website for details.

[White or Dark Lines in Printout](#)

[Blurry or Smearred Printout](#)

[Faint Printout or Printout Has Gaps](#)

[Grainy Printout](#)

[Incorrect Colors](#)

Parent topic: [Solving Problems](#)

White or Dark Lines in Printout

If you notice white or dark lines in your prints (also called banding), try these solutions before you reprint:

- Run a nozzle check to see if any of the print head nozzles are clogged. Then clean the print head, if necessary.
- Make sure the paper type setting matches the type of paper you loaded.
- Make sure you loaded the printable side of the paper correctly for your product.
- Turn off any high speed settings in your product software.
- Align the print head.
- You may need to replace the ink cartridges.

Parent topic: [Solving Print Quality Problems](#)

Related concepts

[Print Head Nozzle Check](#)

[Print Head Cleaning](#)

[Print Head Alignment](#)

Related references

[Paper or Media Type Settings - Control Panel](#)

Related tasks

[Selecting Print Layout Options - Windows](#)

[Selecting Additional Settings - Windows](#)

[Selecting Basic Print Settings - OS X](#)

Related topics

[Loading Media](#)

[Replacing Ink Cartridges](#)

Blurry or Smearred Printout

If your printouts are blurry or smearred, try these solutions:

- Make sure your paper is not damp, curled, old, or loaded incorrectly in your product.
- Use a support sheet with special paper, or load special paper one sheet at a time.
- Make sure your paper meets the specifications for your product.
- Use Epson papers to ensure proper saturation and absorption of genuine Epson inks.
- Make sure the paper type setting in your product software matches the type of paper you loaded.
- Make sure you loaded the printable side of the paper correctly for your product.
- If you are printing on thick paper or poster board, make sure you select the appropriate settings.
- Remove each sheet from the output tray as it is printed.
- Avoid handling printouts on glossy paper right after printing to allow the ink to set.
- Turn off any high speed settings in your product software.
- If you print on both sides of a sheet of paper, smudges may appear on the reverse side of heavily saturated or dark images. If one side of a sheet will contain a lighter image or text, print that side first. Adjust the **Print Density** and/or **Increased Ink Drying Time** settings.
- Run a nozzle check to see if any of the print head nozzles are clogged. Then clean the print head, if necessary.
- Align the print head.
- Clean the paper path.

Note: Your product will not operate properly while tilted at an angle. Place it on a flat, stable surface that extends beyond the base of the product in all directions.

Parent topic: [Solving Print Quality Problems](#)

Related concepts

[Print Head Cleaning](#)

[Print Head Alignment](#)

Related references

[Available Epson Papers](#)

[Paper Specifications](#)

[Double-sided Printing Options - Windows](#)

Related tasks

[Selecting Basic Print Settings - Windows](#)

[Selecting Basic Print Settings - OS X](#)

[Selecting Print Layout Options - Windows](#)

[Selecting Additional Settings - Windows](#)

[Selecting Printing Preferences - OS X](#)

[Cleaning the Paper Guide](#)

Related topics

[Loading Media](#)

Faint Printout or Printout Has Gaps

If your printouts are faint or have gaps, try these solutions:

- Run a nozzle check to see if any of the print head nozzles are clogged. Then clean the print head, if necessary.
- The ink cartridges may be old or low on ink, and you may need to replace them.
- Make sure the paper type setting matches the type of paper you loaded.
- Make sure your paper is not damp, curled, old, or loaded incorrectly in your product.
- Align the print head.
- Clean the paper path.

Parent topic: [Solving Print Quality Problems](#)

Related concepts

[Print Head Nozzle Check](#)

[Print Head Cleaning](#)

[Print Head Alignment](#)

Related references

[Paper or Media Type Settings - Control Panel](#)

Related tasks

[Selecting Basic Print Settings - Windows](#)

[Selecting Basic Print Settings - OS X](#)

[Cleaning the Paper Guide](#)

Related topics

[Loading Media](#)

[Replacing Ink Cartridges](#)

Grainy Printout

If your printouts are grainy, try these solutions:

- Make sure you loaded the printable side of the paper correctly for your product.
- Select a higher print quality setting and turn off any high speed settings in your product software.
- Run a nozzle check to see if any of the print head nozzles are clogged. Then clean the print head, if necessary.
- Align the print head.
- You may need to increase the image resolution or print a smaller size; see your software documentation.

Note: Images from the Internet may be low resolution and not result in a high quality printout.

- If you enlarged the image in an image-editing program, you need to increase the resolution setting to retain a high image quality. Increase the resolution by the same amount you increased the image size. For example, if the resolution is 300 dpi (dots per inch) and you will double the image size later, change the resolution setting to 600 dpi.

Note: Higher resolution settings result in larger file sizes, which take longer to process and print. Consider the limitations of your computer system when selecting a resolution, and select the lowest possible resolution that produces acceptable quality to keep file sizes manageable.

Parent topic: [Solving Print Quality Problems](#)

Related concepts

[Print Head Nozzle Check](#)

[Print Head Cleaning](#)

[Print Head Alignment](#)

Related tasks

[Selecting Basic Print Settings - Windows](#)

[Selecting Basic Print Settings - OS X](#)

[Selecting Print Layout Options - Windows](#)

[Selecting Additional Settings - Windows](#)

Related topics

[Loading Media](#)

Incorrect Colors

If your printouts have incorrect colors, try these solutions:

- Make sure the **Advanced B&W Photo**, **Black/Grayscale** or **Grayscale** setting is not selected in your printer software.
- Run a nozzle check to see if any of the print head nozzles are clogged. Then clean the print head, if necessary.
- The ink cartridges may be old or low on ink, and you may need to replace them.
- Your printed colors can never exactly match your on-screen colors. However, you can use a color management system to get as close as possible. Try using the color management options in your printer software.
- Try turning off the **PhotoEnhance** setting in Windows.
- Try adjusting the **Gamma** setting.
- For best results, use genuine Epson ink and paper.

Parent topic: [Solving Print Quality Problems](#)

Related concepts

[Print Head Nozzle Check](#)

[Print Head Cleaning](#)

Related references

[Available Epson Papers](#)

Related tasks

[Selecting Basic Print Settings - Windows](#)

[Selecting Basic Print Settings - OS X](#)

[Selecting Print Layout Options - Windows](#)

[Selecting Additional Settings - Windows](#)

[Managing Color - OS X](#)

Solving CD/DVD Problems

Check these sections if you have problems printing on a CD/DVD with your product.

[CD/DVD Jam Problems](#)

[Image Not Centered on CD/DVD](#)

[Image Does Not Cover Printable Area of Disc](#)

[Ink Smears on CD/DVD](#)

[Faint Image on CD/DVD](#)

Parent topic: [Solving Problems](#)

CD/DVD Jam Problems

If a CD/DVD has jammed in the product, follow these steps to remove the CD/DVD tray:

1. Cancel the print job from your computer, if necessary.
2. Slowly pull the CD/DVD tray out of the product.

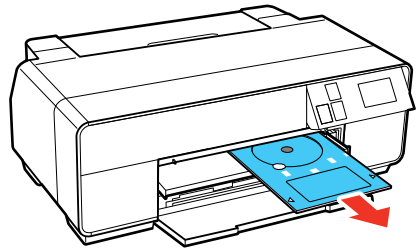

3. Select **Restart**.
4. If an error is still displayed, turn off the product, then turn it back on.
5. If you are unable to remove the CD/DVD tray, contact Epson for support.

Parent topic: [Solving CD/DVD Problems](#)

Image Not Centered on CD/DVD

If your printed image is not centered on the disc, adjust the print position using the Epson Print CD software. See the Epson Print CD help utility for details.

Parent topic: [Solving CD/DVD Problems](#)

Image Does Not Cover Printable Area of Disc

If you are using discs where the printable area extends to within 0.16 inch (4 mm) of the edge of the center hole, you may need to adjust the **Inner/Outer Diameter Setting** in the Epson Print CD software. See the Epson Print CD help utility for details.

Parent topic: [Solving CD/DVD Problems](#)

Ink Smears on CD/DVD

If you notice smeared ink on your disc, try these solutions:

- Make sure you are printing on ink jet-printable CDs or DVDs and that the surface of the disc is dry.
- Handle printed discs carefully and let them dry for 24 hours before inserting them in a drive.
- Adjust the print quality using the Epson Print CD software. See the Epson Print CD help utility for details.

Parent topic: [Solving CD/DVD Problems](#)

Faint Image on CD/DVD

If your printed image is faint, adjust the print quality using the Epson Print CD software. See the Epson Print CD help utility for details.

Parent topic: [Solving CD/DVD Problems](#)

Uninstall Your Product Software

If you have a problem that requires you to uninstall and re-install your software, follow the instructions for your operating system.

[Uninstalling Printing Software - Windows](#)

[Uninstalling Product Software - OS X](#)

Parent topic: [Solving Problems](#)

Uninstalling Printing Software - Windows

You can uninstall and then re-install your printer software to solve certain problems.

1. Turn off the product.
2. Disconnect any interface cables.
3. Do one of the following:
 - **Windows 8.x:** Navigate to the **Apps** screen and select **Control Panel > Programs > Programs and Features**. Select the uninstall option for your Epson product, then select **Uninstall/Change**.

Note: If you see a **User Account Control** window, click **Yes** or **Continue**.

In the next window, select your product, if necessary, and click **OK**. Then follow any on-screen instructions.

- **Windows (other versions):** Click  or **Start**, and select **All Programs** or **Programs**. Select **Epson**, select your product, then click **EPSON Printer Software Uninstall**.

Note: If you see a **User Account Control** window, click **Yes** or **Continue**.

In the next window, select your product, if necessary, and click **OK**. Then follow any on-screen instructions.

4. Restart your computer, then re-install your software.

Note: If you find that re-installing your product software does not solve a problem, contact Epson.

Parent topic: [Uninstall Your Product Software](#)

Uninstalling Product Software - OS X

In most cases, you do not need to uninstall your product software before re-installing it. However, you can download the Uninstaller utility from the Epson support website to uninstall your product software as described here.

Note: If you find that re-installing your product software does not solve a problem, contact Epson.

1. To download the Uninstaller utility, visit the Epson download site ([U.S. downloads](#) or [Canadian downloads](#)).

2. Follow the instructions on the screen to install the Uninstaller utility.
3. Quit all applications currently running on your Mac.
4. Double-click the **Uninstaller** icon.
5. Select the checkbox for each software program you want to uninstall.
6. Click **Uninstall**.
7. Follow the on-screen instructions to uninstall the software.
8. To reinstall your product software, see the *Start Here* sheet for instructions.

Note: If you uninstall the printer driver and your product name remains in the **Print & Fax**, **Print & Scan**, or **Printers & Scanners** window, select your product name and click the – (remove) icon to remove it.

Parent topic: [Uninstall Your Product Software](#)

Where to Get Help

If you need to contact Epson for technical support services, use the following support options.

Internet Support

Visit Epson's support website at epson.com/support (U.S.) or epson.ca/support (Canada) for solutions to common problems. You can download drivers and documentation, get FAQs and troubleshooting advice, or e-mail Epson with your questions.

Speak to a Support Representative

Before you call Epson for support, please have the following information ready:

- Product name
- Product serial number (located on a label on the product)
- Proof of purchase (such as a store receipt) and date of purchase
- Computer configuration
- Description of the problem

Then call:

- U.S.: (562) 276-7272, 6 AM to 8 PM, Pacific Time, Monday through Friday, and 7 AM to 4 PM, Pacific Time, Saturday

- Canada: (905) 709-2567, 6 AM to 8 PM, Pacific Time, Monday through Friday, and 7 AM to 4 PM, Pacific Time, Saturday

Days and hours of support are subject to change without notice. Toll or long distance charges may apply.

Purchase Supplies and Accessories

You can purchase genuine Epson ink and paper at epson.com/ink3 (U.S. sales) or epson.ca (Canadian sales). You can also purchase supplies from an Epson authorized reseller. To find the nearest one, call 800-GO-EPSON (800-463-7766).

Parent topic: [Solving Problems](#)

Technical Specifications

These sections list the technical specifications for your product.

Note: Epson offers a recycling program for end of life products. Please go to [this site](#) for information on how to return your products for proper disposal.

[Windows System Requirements](#)

[OS X System Requirements](#)

[Paper Specifications](#)

[Printable Area Specifications](#)

[Ink Cartridge Specifications](#)

[Dimension Specifications](#)

[Electrical Specifications](#)

[Environmental Specifications](#)

[Interface Specifications](#)

[Network Interface Specifications](#)

[Safety and Approvals Specifications](#)

Windows System Requirements

To use your product and its software, your computer should use one of these Microsoft operating systems:

- Windows 8.x
- Windows 7

Note: Visit Epson's support website at epson.com/support (U.S.) or epson.ca/support (Canada) for the latest in compatibility and drivers for your product.

Parent topic: [Technical Specifications](#)

OS X System Requirements

To use your product and its software, your Mac should use one of these operating systems:

- OS X 10.10.x

- OS X 10.9.x
- OS X 10.8.x
- OS X 10.7.x

Note: Visit Epson's support website at epson.com/support (U.S.) or epson.ca/support (Canada) for the latest in compatibility and drivers for your product.

Parent topic: [Technical Specifications](#)

Paper Specifications

Note: Since the quality of any particular brand or type of paper may be changed by the manufacturer at any time, Epson cannot guarantee the quality of any non-Epson brand or type of paper. Always test a sample of paper stock before purchasing large quantities or printing large jobs.

Cut sheets - plain paper

Capacity

Paper stack up to 0.47 inch (12 mm) thick of these paper sizes:

A4 (8.3 × 11.7 inches [210 × 297 mm])

B5 (7.2 × 10.1 inches [182 × 257 mm])

A5 (5.8 × 8.2 inches [148 × 210 mm])

A6 (4.1 × 5.8 inches [105 × 148 mm])

Letter (8.5 × 11 inches [216 × 279 mm])

Stack up to 0.20 inch (5 mm) thick on these paper sizes:

A3 (11.7 × 16.5 inches [297 × 420 mm])

B4 (13.9 × 9.84 inches [353 × 250 mm])

Legal (8.5 × 14 inches [216 × 356 mm])

Non-standard sizes between 3.5 inches (89 mm) and 13 inches (329 mm) wide, and between 5 inches (127 mm) and 44 inches (1117.6 mm) long

Thickness

0.003 to 0.004 inch (0.08 to 0.11 mm)

Weight

17 lb (64 g/m²) to 20 lb (90 g/m²)

Cut sheets - thick paper

Size	A4 (8.3 × 11.7 inches [210 × 297 mm]) A3 (11.7 × 16.5 inches [297 × 420 mm]) 13 × 19 inches (330 × 483 mm) Letter (8.5 × 11 inches [216 × 279 mm]) 11 × 17 inches (279 × 432 mm)
Capacity	1 sheet
Thickness	Fine art media: 0.012 inch (0.3 mm) to 0.023 inch (0.7 mm) Poster board: 0.023 inch (0.7 mm) to 0.051 inch (1.3 mm)

Roll paper

Size	Roll paper width: 13 inches (329 mm)
Thickness	0.003 to 0.004 inch (0.08 to 0.11 mm)
Weight	17 lb (64 g/m ²) to 20 lb (90 g/m ²)

Parent topic: [Technical Specifications](#)

Printable Area Specifications

Note: When printing borderless, quality may decline in the expanded printable area.

Cut sheets - normal printing

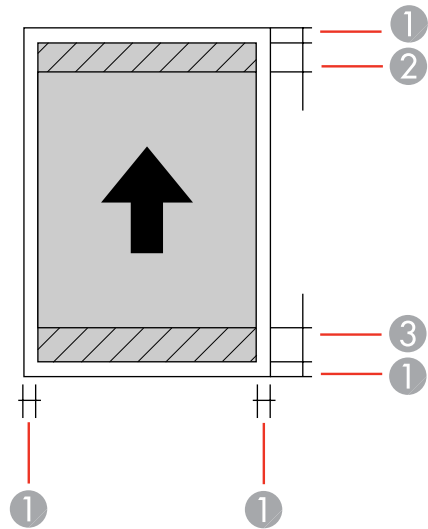

- 1 Top and side margins: 0.12 inch (3 mm) minimum
- 2 Top/reduced print quality area: 1.30 inches (33 mm) minimum
- 3 Bottom/reduced print quality area: 1.42 inches (36 mm) minimum

Note: Poster board margins are 0.79 inch (20 mm) for sizes smaller than 13 × 19 inches (330 × 483 mm).

Cut sheets - borderless printing

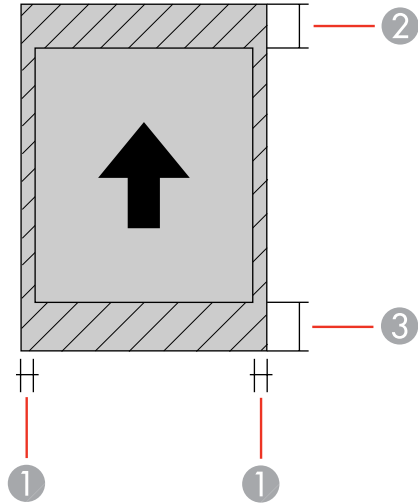

- 1 Side/reduced print quality area: 0.12 inch (3 mm) minimum
- 2 Top/reduced print quality area: 1.42 inches (36 mm) minimum
- 3 Bottom/reduced print quality area: 1.54 inches (39 mm) minimum

Note: You cannot print borderless on poster board.

Roll paper - normal printing

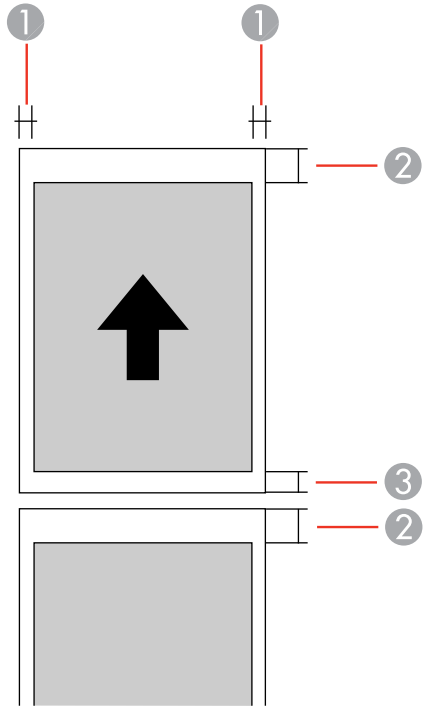

- 1 Side margins: 0.12 inch (3 mm) minimum
- 2 Top margin: 1.97 inches (50 mm) minimum
- 3 Bottom margin: 0.55 inch (14 mm) minimum

Roll paper - borderless printing

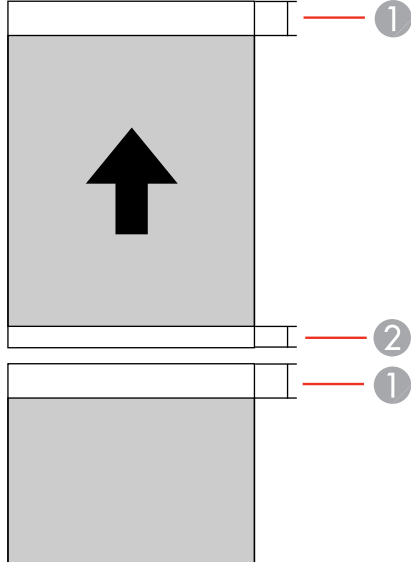

- 1 Top margin: 1.97 inches (50 mm) minimum
- 2 Bottom margin: 0.55 inch (14 mm) minimum

Note: For continuous printing on roll paper, there is no margin between printed images (normal and borderless printing).

CD/DVD

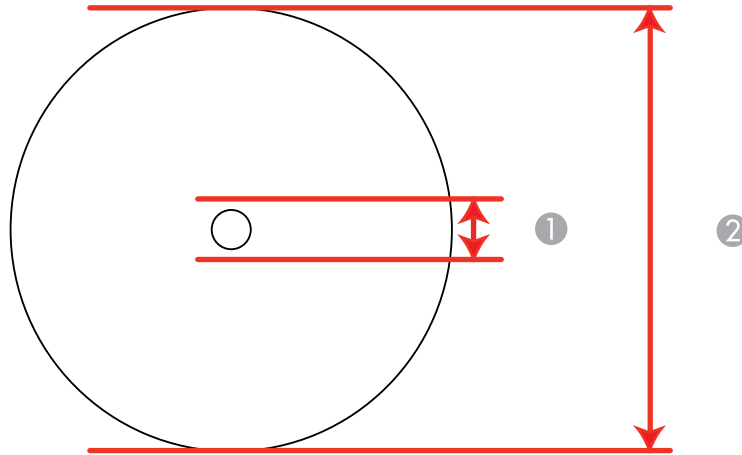

- 1 Minimum inner margin: 0.83 inch (21 mm)
- 2 Maximum outer margin: 4.72 inch (120 mm)

Parent topic: [Technical Specifications](#)

Ink Cartridge Specifications

Note: We recommend that you use genuine Epson cartridges and do not refill them. The use of other products may affect your print quality and could result in printer damage.

The cartridges included with the printer are designed for printer setup and not for resale. After some ink is used for charging, the rest is available for printing. Yields vary considerably based on images printed, print settings, paper type, frequency of use, and temperature. For print quality, a variable amount of ink remains in the cartridge after the "replace cartridge" indicator comes on.

Color

Black cartridge: Photo Black, Matte Black, Light Black, and Light Light Black inks

Color cartridge: Yellow, Cyan, Light Cyan, Vivid Magenta, and Vivid Light Magenta inks

Cartridge life	Opened package: 6 months Unopened package: do not use if the date on the package has expired
Temperature	Storage: -4 to 104 °F (-20 to 40 °C) Within a month at 104 °F (40 °C) Ink freezes at 5 °F (-15 °C); if left for a long time Ink thaws and is usable after 3 hours at 77 °F (25 °C) with no condensation

Note: For best printing results, use up a cartridge within 6 months of opening the package.

Parent topic: [Technical Specifications](#)

Related references

[Ink Cartridge Part Numbers](#)

Dimension Specifications

Height	Stored: 9.0 inches (228 mm) Printing: 16.7 inches (424 mm)
Width	Stored: 24.3 inches (616 mm) Printing: 24.3 inches (616 mm)
Depth	Stored: 14.5 inches (369 mm) Printing: 32.0 inches (814 mm)
Weight (without ink cartridges)	33.1 lb (15.0 kg)

Parent topic: [Technical Specifications](#)

Electrical Specifications

Power supply rating	100 to 120 V 220 to 240 V
----------------------------	------------------------------

Input voltage range	100 to 120 V model: 90 to 132 V 220 to 240 V model: 198 to 264 V
Rated frequency range	50/60 Hz
Input frequency range	49.5/60.5 Hz
Rated current	100 to 120 V model: 0.6 A 220 to 240 V model: 0.3 A
Power consumption (100 to 120 V model)	Printing: Approximately 20 W (ISO/IEC24712) Ready mode: Approximately 5.3 W Sleep mode: Approximately 1.4 W Power off mode: Approximately 0.15 W
Power consumption (200 to 240 V model)	Printing: Approximately 20 W (ISO/IEC24712) Ready mode: Approximately 5.3 W Sleep mode: Approximately 1.4 W Power off mode: Approximately 0.3 W

Parent topic: [Technical Specifications](#)

Environmental Specifications

Temperature	Operating: 50 to 95 °F (10 to 35 °C) Storage before unpacking: –4 to 140 °F (–20 to 60 °C) Within 120 hours at 140 °F (60 °C); within a month at 104 °F (40 °C) Storage after unpacking: –4 to 140 °F (–20 to 60 °C) Within a month at 104 °F (40 °C)
Humidity (without condensation)	Operating: 20 to 80% RH Storage: 5 to 85% RH

Parent topic: [Technical Specifications](#)

Interface Specifications

One High-Speed USB port for connection to computer

Parent topic: [Technical Specifications](#)

Network Interface Specifications

Wi-Fi

Standard	IEEE 802.11 b/g/n
Security	WPA-PSK (TKIP/AES); complies with WPA2 WEP (64/128 bit)
Frequency band	2.4 GHz
Communication mode	Infrastructure mode Ad hoc mode (IEEE 802.11 n not supported in this mode)

Ethernet

Ethernet 100BASE-TX/10 Base T standard

Parent topic: [Technical Specifications](#)

Safety and Approvals Specifications

United States	Safety: UL60950-1 EMC: FCC part 15 Subpart B class B
Canada	Safety: CAN/CSA C22.2 No. 60950-1 EMC: CAN/CSA-CEI/IEC CISPR 22 Class B [CAN ICES-3(B)/NMB-3(B)]

This equipment contains the following wireless module:

- Manufacturer: Askey Computer Corporation.
- Type: WLU6117-D69 (RoHS)

This product conforms to Part 15 of FCC Rules and RSS-210 of the IC Rules. Epson cannot accept responsibility for any failure to satisfy the protection requirements resulting from a non-recommended modification of the product. Operation is subject to the following two conditions: (1) this device may not cause harmful interference, and (2) this device must accept any interference received, including interference that may cause undesired operation of the device.

To prevent radio interference to the licensed service, this device is intended to be operated indoors and away from windows to provide maximum shielding. Equipment (or its transmit antenna) that is installed outdoors is subject to licensing.

Parent topic: [Technical Specifications](#)

Notices

Check these sections for important notices about your product.

Note: Epson offers a recycling program for end of life products. Please go to [this site](#) for information on how to return your products for proper disposal.

[Important Safety Instructions](#)

[FCC Compliance Statement](#)

[Trademarks](#)

[Copyright Notice](#)

Important Safety Instructions

Before using your Epson product, read and follow these safety instructions.

[General Printer Safety Instructions](#)

[Ink Cartridge Safety Instructions](#)

[LCD Screen Safety Instructions](#)

[Wireless Connection Safety Instructions](#)

Parent topic: [Notices](#)

General Printer Safety Instructions

- Be sure to follow all warnings and instructions marked on the printer.
- Use only the type of power source indicated on the printer's label.
- Use only the power cord that comes with the printer. Use of another cord may cause fires or shock. Do not use the cord with any other equipment.
- Place the printer near a wall outlet where the plug can be easily unplugged.
- Avoid plugging the printer into an outlet on the same circuit as a photo copier or air control system that regularly switches on and off, or on an outlet controlled by a wall switch or timer.
- Do not let the power cord become damaged or frayed.
- If you use an extension cord with the printer, make sure the total ampere rating of the devices plugged into the extension cord does not exceed the cord's ampere rating. Also, make sure the total ampere rating of all devices plugged into the wall outlet does not exceed the wall outlet's ampere rating.

- Always turn off the printer using the power button, and wait until the power light stops flashing before unplugging the printer or cutting off power to the electrical outlet.
- Place the printer on a flat, stable surface that extends beyond its base in all directions. It will not operate properly if it is tilted or at an angle.
- Leave enough space in front of the printer for the paper to be fully ejected.
- Avoid locations that are subject to rapid changes in heat or humidity, shocks or vibrations, or dust.
- Do not place the printer near a radiator or heating vent or in direct sunlight.
- Leave enough room around the printer for sufficient ventilation. Do not block or cover openings in the case or insert objects through the slots.
- Keep the printer away from potential sources of electromagnetic interference, such as loudspeakers or the base units of cordless telephones.
- When connecting the printer to a computer or other device with a cable, ensure the correct orientation of the connectors. Each connector has only one correct orientation. Inserting a connector in the wrong orientation may damage both devices connected by the cable.
- Do not touch the flat white cable inside the printer.
- Do not move the print head by hand; this may damage the printer.
- Do not spill liquid on the printer.
- Do not use aerosol products that contain flammable gases inside or around the printer. Doing so may cause fire.
- Except as specifically explained in your documentation, do not attempt to service the printer yourself.
- Unplug the printer and refer servicing to qualified service personnel under the following conditions: if the power cord or plug is damaged; if liquid has entered the product; if the product has been dropped or the case damaged; if the product does not operate normally or exhibits a distinct change in performance. Adjust only those controls that are covered by the operating instructions.
- If damage occurs to the plug, replace the cord set or consult a qualified electrician. If there are fuses in the plug, make sure you replace them with fuses of the correct size and rating.
- Leave the ink cartridges installed. Removing the cartridges can dehydrate the print head and may prevent the printer from printing.
- Before transporting the printer, make sure that the print head is in the home (far right) position and the ink cartridges are in place.
- When storing or transporting the printer, do not tilt it, stand it on its side, or turn it upside down; otherwise ink may leak from the cartridges.

Parent topic: [Important Safety Instructions](#)

Ink Cartridge Safety Instructions

- Keep ink cartridges out of the reach of children and do not drink the ink.
- Be careful when you handle used ink cartridges; there may be ink remaining around the ink supply port. If ink gets on your skin, wash it off with soap and water. If it gets in your eyes, flush them immediately with water.
- Do not put your hand inside the product or touch any cartridges during printing.
- Install a new ink cartridge immediately after removing an expended one. Leaving cartridges uninstalled can dry out the print head and may prevent the product from printing.
- Do not remove or tear the label on the cartridge; this can cause leakage.
- Do not remove the transparent seal from the bottom of the cartridge. This may cause the cartridge to become unusable.
- Do not break the hooks on the side of the cartridge when removing it from the packaging.
- Do not touch the green IC chip on the side of the cartridge. This may prevent normal operation.
- Do not shake cartridges after opening their packages; this can cause them to leak.
- If you remove an ink cartridge for later use, protect the ink supply area from dirt and dust and store it in the same environment as the product. Note that there is a valve in the ink supply port, making covers or plugs unnecessary, but care is needed to prevent the ink from staining items that the cartridge touches. Do not touch the ink cartridge ink supply port or surrounding area.
- Use an ink cartridge before the date printed on its package.
- Do not dismantle an ink cartridge. This could damage the print head.
- Store ink cartridges in a cool, dark place.
- After bringing an ink cartridge inside from a cold storage site, allow it to warm up at room temperature for at least three hours before using it.
- Store ink cartridges with their labels facing upward. Do not store cartridges upside down.

Parent topic: [Important Safety Instructions](#)

LCD Screen Safety Instructions

- Use only a dry, soft cloth to clean the LCD screen. Do not use liquid or chemical cleansers.
- If the LCD screen is damaged, contact Epson. If the liquid crystal solution gets on your hands, wash them thoroughly with soap and water. If the liquid crystal solution gets into your eyes, flush them

immediately with water. If discomfort or vision problems remain after a thorough flushing, see a doctor immediately.

- Do not press too hard on the LCD screen.
- Do not use a pointy or sharp object, such as a pen or your fingernail, to operate the LCD screen.

Parent topic: [Important Safety Instructions](#)

Wireless Connection Safety Instructions

Radio waves from this product may adversely affect the operation of medical equipment or automatically controlled devices, such as pacemakers, automatic doors or fire alarms. When using this product near such devices or inside a medical facility, follow the directions from authorized staff members at the facility, and follow all posted warnings and directions on the device to avoid causing an accident.

Parent topic: [Important Safety Instructions](#)

FCC Compliance Statement

For United States Users

This equipment has been tested and found to comply with the limits for a Class B digital device, pursuant to Part 15 of the FCC Rules. These limits are designed to provide reasonable protection against harmful interference in a residential installation. This equipment generates, uses, and can radiate radio frequency energy and, if not installed and used in accordance with the instructions, may cause harmful interference to radio or television reception. However, there is no guarantee that interference will not occur in a particular installation. If this equipment does cause interference to radio and television reception, which can be determined by turning the equipment off and on, the user is encouraged to try to correct the interference by one or more of the following measures:

- Reorient or relocate the receiving antenna.
- Increase the separation between the equipment and receiver.
- Connect the equipment into an outlet on a circuit different from that to which the receiver is connected.
- Consult the dealer or an experienced radio/TV technician for help.

WARNING

The connection of a non-shielded equipment interface cable to this equipment will invalidate the FCC Certification or Declaration of this device and may cause interference levels which exceed the limits established by the FCC for this equipment. It is the responsibility of the user to obtain and use a shielded equipment interface cable with this device. If this equipment has more than one interface connector, do

not leave cables connected to unused interfaces. Changes or modifications not expressly approved by the manufacturer could void the user's authority to operate the equipment.

For Canadian Users

CAN ICES-3(B)/NMB-3(B)

Parent topic: [Notices](#)

Trademarks

EPSON®, Epson UltraChrome®, Signature Worthy®, and SureColor® are registered trademarks; Epson Connect™ is a trademark; and EPSON Exceed Your Vision is a registered logomark of Seiko Epson Corporation.

UltraSmooth® is a registered trademark, Designed for Excellence™ is a trademark, and Epson StoreSM is a service mark of Epson America, Inc.

Epson iPrint™ and Remote Print™ are trademarks of Seiko Epson Corporation.

Apple, iPad, iPhone, iPod touch, Mac, and OS X are trademarks of Apple Inc., registered in the U.S. and other countries. AirPrint and the AirPrint logo are trademarks of Apple Inc.

Google® is a registered trademark and Android™, Chromebook™, Gmail™, Google Chrome™, Google Cloud Print™, Google Drive™, Picasa™ and YouTube™ are trademarks of Google Inc.

Wi-Fi Direct® is a registered trademark of Wi-Fi Alliance®.

General Notice: Other product names used herein are for identification purposes only and may be trademarks of their respective owners. Epson disclaims any and all rights in those marks.



Parent topic: [Notices](#)

Copyright Notice

All rights reserved. No part of this publication may be reproduced, stored in a retrieval system, or transmitted in any form or by any means, electronic, mechanical, photocopying, recording, or otherwise, without the prior written permission of Seiko Epson Corporation. The information contained herein is designed only for use with this Epson product. Epson is not responsible for any use of this information as applied to other products.

Neither Seiko Epson Corporation nor its affiliates shall be liable to the purchaser of this product or third parties for damages, losses, costs, or expenses incurred by purchaser or third parties as a result of: accident, misuse, or abuse of this product or unauthorized modifications, repairs, or alterations to this product, or (excluding the U.S.) failure to strictly comply with Seiko Epson Corporation's operating and maintenance instructions.

Seiko Epson Corporation shall not be liable for any damages or problems arising from the use of any options or any consumable products other than those designated as Original Epson Products or Epson Approved Products by Seiko Epson Corporation.

Seiko Epson Corporation shall not be held liable for any damage resulting from electromagnetic interference that occurs from the use of any interface cables other than those designated as Epson approved Products by Seiko Epson Corporation.

This information is subject to change without notice.

[A Note Concerning Responsible Use of Copyrighted Materials](#)
[Default Delay Times for Power Management for Epson Products](#)
[Copyright Attribution](#)

Parent topic: [Notices](#)

A Note Concerning Responsible Use of Copyrighted Materials

Epson encourages each user to be responsible and respectful of the copyright laws when using any Epson product. While some countries' laws permit limited copying or reuse of copyrighted material in certain circumstances, those circumstances may not be as broad as some people assume. Contact your legal advisor for any questions regarding copyright law.

Parent topic: [Copyright Notice](#)

Default Delay Times for Power Management for Epson Products

This product will enter sleep mode after a period of nonuse. This is to ensure that the product meets Energy Star standards of energy efficiency. More energy savings can be achieved by setting the time to sleep to a shorter interval.

Parent topic: [Copyright Notice](#)

Copyright Attribution

© 2015 Epson America, Inc.

6/15

CPD-41370R1

Parent topic: [Copyright Notice](#)